

SPILLSTENSILER NM Damer, 03. august 2010

♠ KQ9 Mappen: 1(1)
 ♥ K3 Rundenr: 1
 ♦ QJ873 I (N)
 ♣ AJ2

♠ J43
 ♥ AQ42
 ♦ A9
 ♣ K876

♠ Q92 Mappen: 3(3)
 ♥ K976 Rundenr: 2
 ♦ T86 ØV (S)
 ♣ QJ9

♠ 83
 ♥ Q543
 ♦ J43
 ♣ 8754

Bord	NS	ØV	NS	ØV	NS	ØV
14	31	14	3Kløver	D V 2	1700	21,0 -21,0
13	13	32	3NT	N 12	490	19,0 -19,0
9	9	36	3NT	N 11	460	5,0 -5,0
19	19	26	3NT	N 11	460	5,0 -5,0
21	21	24	3NT	N 11	460	5,0 -5,0
12	33	12	3NT	N 11	460	5,0 -5,0
20	20	25	3NT	N 11	460	5,0 -5,0
3	3	42	3NT	N 11	460	5,0 -5,0
22	23	22	3NT	N 11	460	5,0 -5,0
8	8	37	3NT	N 11	460	5,0 -5,0
17	28	17	3NT	N 11	460	5,0 -5,0
11	34	11	3NT	N 11	460	5,0 -5,0
16	29	16	3NT	N 11	460	5,0 -5,0
1	44	1	3NT	N 11	460	5,0 -5,0
2	43	2	3NT	N 11	460	5,0 -5,0
5	40	5	3NT	N 10	430	-14,0 14,0
10	35	10	3NT	N 10	430	-14,0 14,0
6	6	39	3NT	N 10	430	-14,0 14,0
7	38	7	3NT	N 10	430	-14,0 14,0
15	30	15	3NT	N 10	430	-14,0 14,0
18	27	18	3NT	N 10	430	-14,0 14,0
4	4	41	6NT	S 10	100	-21,0 21,0

Bord	NS	ØV	NS	ØV	NS	ØV
12	34	13	4 Spar	Ø 11	650	20,0 -20,0
10	36	11	4 Spar	Ø 11	650	20,0 -20,0
3	4	43	3NT	Ø 11	660	17,0 -17,0
7	39	8	4 Spar	Ø 12	680	12,0 -12,0
8	9	38	4 Spar	Ø 12	680	12,0 -12,0
4	5	42	4 Spar	Ø 12	680	12,0 -12,0
9	10	37	4 Spar	V 12	680	12,0 -12,0
5	41	6	3NT	Ø 12	690	7,0 -7,0
21	22	25	4 Spar	Ø 13	710	-4,0 4,0
22	24	23	4 Spar	Ø 13	710	-4,0 4,0
14	32	15	4 Spar	Ø 13	710	-4,0 4,0
11	35	12	4 Spar	Ø 13	710	-4,0 4,0
19	20	27	4 Spar	Ø 13	710	-4,0 4,0
15	31	16	4 Spar	Ø 13	710	-4,0 4,0
13	14	33	4 Spar	Ø 13	710	-4,0 4,0
6	7	40	4 Spar	Ø 13	710	-4,0 4,0
17	29	18	4 Spar	Ø 13	710	-4,0 4,0
18	28	19	5 Spar	Ø 13	710	-4,0 4,0
2	1	3	3NT	Ø 13	720	-15,0 15,0
1	44	2	6 Spar	Ø 12	1430	-17,0 17,0
16	30	17	6 Spar	Ø 13	1460	-20,0 20,0
20	21	26	6 Spar	Ø 13	1460	-20,0 20,0

♠ Q65 Mappen: 2(2)
 ♥ AK86 Rundenr: 1
 ♦ T76532 NS (Ø)
 ♣ T76532

♠ A974
 ♥ J9732
 ♦ J974
 ♣

♠ J653 Mappen: 4(4)
 ♥ KJ964 Rundenr: 2
 ♦ J2 A (V)
 ♣ 98

♠ T872
 ♥ 83
 ♦ T8
 ♣ QT763

Bord	NS	ØV	NS	ØV	NS	ØV
10	35	10	3Ruter	Ø 5	200	21,0 -21,0
13	13	32	4Hjerter	V 7	150	19,0 -19,0
19	19	26	4Hjerter	V 8	100	6,0 -6,0
3	3	42	4Hjerter	Ø 8	100	6,0 -6,0
22	23	22	4Hjerter	Ø 8	100	6,0 -6,0
12	33	12	4Hjerter	V 8	100	6,0 -6,0
18	27	18	4Hjerter	V 8	100	6,0 -6,0
21	21	24	4Hjerter	V 8	100	6,0 -6,0
7	38	7	4Hjerter	V 8	100	6,0 -6,0
16	29	16	4Hjerter	V 8	100	6,0 -6,0
14	31	14	4Hjerter	V 8	100	6,0 -6,0
4	4	41	4Hjerter	Ø 8	100	6,0 -6,0
6	6	39	4Hjerter	V 8	100	6,0 -6,0
8	8	37	4Hjerter	V 8	100	6,0 -6,0
15	30	15	3Hjerter	Ø 8	50	-12,0 12,0
5	40	5	4Hjerter	V 9	50	-12,0 12,0
1	44	1	4Hjerter	Ø 9	50	-12,0 12,0
9	9	36	4Hjerter	V 9	50	-12,0 12,0
17	28	17	4Hjerter	V 9	50	-12,0 12,0
2	43	2	4Hjerter	V 9	50	-12,0 12,0
11	34	11	1NT	Ø 9	150	-19,0 19,0
20	20	25	3NT	V 10	430	-21,0 21,0

Bord	NS	ØV	NS	ØV	NS	ØV
15	31	16	6NT	Ø 10	200	21,0 -21,0
20	21	26	6NT	Ø 11	100	19,0 -19,0
5	41	6	5Ruter	V 13	640	17,0 -17,0
4	5	42	3NT	Ø 12	690	14,0 -14,0
8	9	38	3NT	Ø 12	690	14,0 -14,0
12	34	13	3NT	V 13	720	9,0 -9,0
19	20	27	3NT	V 13	720	9,0 -9,0
14	32	15	4NT	Ø 13	720	9,0 -9,0
13	14	33	6NT	Ø 12	1440	0,0 0,0
21	22	25	6NT	Ø 12	1440	0,0 0,0
10	36	11	6NT	Ø 12	1440	0,0 0,0
22	24	23	6NT	Ø 12	1440	0,0 0,0
1	44	2	6NT	Ø 12	1440	0,0 0,0
16	30	17	6NT	Ø 12	1440	0,0 0,0
2	1	3	6NT	Ø 13	1470	-13,0 13,0
11	35	12	6NT	Ø 13	1470	-13,0 13,0
18	28	19	6NT	Ø 13	1470	-13,0 13,0
3	4	43	6NT	V 13	1470	-13,0 13,0
7	39	8	6NT	Ø 13	1470	-13,0 13,0
6	7	40	6NT	Ø 13	1470	-13,0 13,0
9	10	37	6NT	V 13	1470	-13,0 13,0
17	29	18	7NT	Ø 13	2220	-21,0 21,0

SPILLSTENSILER NM Damer, 03. august 2010

♠ 76432 Mappenr: 5(5)
 ♥ J82 Rundenr: 3
 ♦ 9 NS (N)

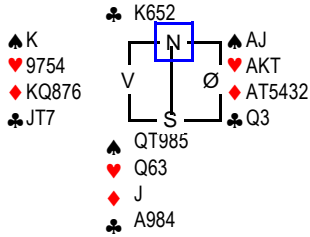

Bord	NS	ØV	NS	ØV	NS	ØV
20	22	27	5 Ruter	Ø 10	50	19,0 -19,0
11	36	13	6 Ruter	Ø 11	50	19,0 -19,0
21	23	26	6 Ruter	Ø 11	50	19,0 -19,0
9	11	38	4 Ruter	V 10	130	15,0 -15,0
10	37	12	3 Ruter	Ø 11	150	12,0 -12,0
15	32	17	4 Ruter	Ø 11	150	12,0 -12,0
1	44	3	5 Ruter	Ø 11	400	5,0 -5,0
12	35	14	5 Ruter	Ø 11	400	5,0 -5,0
2	2	4	5 Ruter	Ø 11	400	5,0 -5,0
8	10	39	5 Ruter	Ø 11	400	5,0 -5,0
17	30	19	5 Ruter	Ø 11	400	5,0 -5,0
7	40	9	4 Hjerter	V 10	420	-2,0 2,0
19	21	28	4 Hjerter	Ø 10	420	-2,0 2,0
22	25	24	3 NT	V 10	430	-8,0 8,0
16	31	18	3 NT	Ø 10	430	-8,0 8,0
5	42	7	3 NT	Ø 10	430	-8,0 8,0
3	5	1	3 NT	Ø 10	430	-8,0 8,0
13	15	34	4 Hjerter	Ø 11	450	-13,0 13,0
4	6	43	3 NT	Ø 11	460	-17,0 17,0
6	8	41	3 NT	Ø 11	460	-17,0 17,0
18	29	20	3 NT	Ø 11	460	-17,0 17,0
14	33	16	3 Spar	D S 7	500	-21,0 21,0

♠ 3 Mappenr: 7(7)
 ♥ J962 Rundenr: 4
 ♦ KJT32 A (S)
 ♣ T84

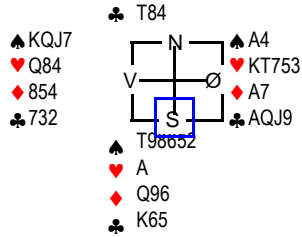

Bord	NS	ØV	NS	ØV	NS	ØV
8	11	40	3 NT	V 8	100	17,0 -17,0
4	7	1	3 NT	V 8	100	17,0 -17,0
16	32	19	3 NT	V 8	100	17,0 -17,0
13	16	35	3 NT	V 8	100	17,0 -17,0
3	6	2	4 Hjerter	Ø 9	100	17,0 -17,0
17	31	20	3 Hjerter	Ø 10	170	11,0 -11,0
1	44	4	2 Spar	D S 6	500	9,0 -9,0
21	24	27	4 Hjerter	Ø 10	620	-6,0 6,0
11	37	14	4 Hjerter	Ø 10	620	-6,0 6,0
15	33	18	4 Hjerter	V 10	620	-6,0 6,0
7	41	10	4 Hjerter	Ø 10	620	-6,0 6,0
18	30	21	4 Hjerter	Ø 10	620	-6,0 6,0
10	38	13	4 Hjerter	Ø 10	620	-6,0 6,0
20	23	28	4 Hjerter	Ø 10	620	-6,0 6,0
22	26	25	4 Hjerter	Ø 10	620	-6,0 6,0
19	22	29	4 Hjerter	Ø 10	620	-6,0 6,0
14	34	17	4 Hjerter	Ø 10	620	-6,0 6,0
9	12	39	4 Hjerter	Ø 10	620	-6,0 6,0
2	3	5	4 Hjerter	Ø 10	620	-6,0 6,0
5	43	8	4 Hjerter	Ø 10	620	-6,0 6,0
12	36	15	4 Hjerter	Ø 10	620	-6,0 6,0
6	9	42	4 Hjerter	Ø 11	650	-21,0 21,0

♠ Q5 Mappenr: 6(6)
 ♥ 942 Rundenr: 3
 ♦ AT962 ØV (Ø)
 ♣ KT5

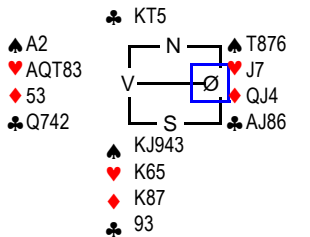

Bord	NS	ØV	NS	ØV	NS	ØV
6	8	41	3 Kløver	N 10	130	21,0 -21,0
10	37	12	3 Kløver	V 8	100	19,0 -19,0
16	31	18	2 Spar	S 6	100	16,0 -16,0
18	29	20	3 Ruter	N 7	100	16,0 -16,0
3	5	1	2 Kløver	V 9	110	11,0 -11,0
20	22	27	3 Kløver	V 9	110	11,0 -11,0
2	2	4	3 Kløver	V 9	110	11,0 -11,0
7	40	9	1 NT	V 8	120	7,0 -7,0
11	36	13	2 Kløver	V 10	130	2,0 -2,0
19	21	28	3 Kløver	V 10	130	2,0 -2,0
1	44	3	3 Kløver	V 10	130	2,0 -2,0
21	23	26	3 Kløver	V 10	130	2,0 -2,0
12	35	14	2 Hjerter	V 9	140	-8,0 8,0
9	11	38	2 Hjerter	Ø 9	140	-8,0 8,0
13	15	34	2 Hjerter	V 9	140	-8,0 8,0
15	32	17	2 Hjerter	V 9	140	-8,0 8,0
4	6	43	2 Hjerter	V 9	140	-8,0 8,0
8	10	39	2 Hjerter	V 9	140	-8,0 8,0
5	42	7	1 NT	V 9	150	-17,0 17,0
14	33	16	1 NT	V 9	150	-17,0 17,0
17	30	19	3 Ruter	N 6	150	-17,0 17,0
22	25	24	1 NT	V 11	210	-21,0 21,0

♠ 9643 Mappenr: 8(8)
 ♥ A743 Rundenr: 4
 ♦ 432 I (V)
 ♣ 94

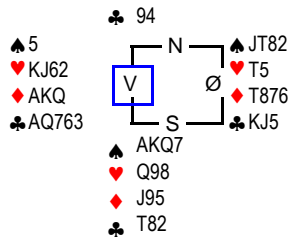

Bord	NS	ØV	NS	ØV	NS	ØV
16	32	19	3 NT	V 7	100	21,0 -21,0
19	22	29	3 NT	V 8	50	18,0 -18,0
22	26	25	5 Kløver	V 10	50	18,0 -18,0
4	7	1	2 Spar	S 6	100	14,0 -14,0
21	24	27	2 Spar	S 6	100	14,0 -14,0
14	34	17	3 Ruter	Ø 9	110	11,0 -11,0
9	12	39	2 Kløver	V 10	130	6,0 -6,0
20	23	28	2 Kløver	V 10	130	6,0 -6,0
12	36	15	2 Kløver	V 10	130	6,0 -6,0
7	41	10	3 Kløver	V 10	130	6,0 -6,0
11	37	14	1 NT	V 9	150	0,0 0,0
13	16	35	3 Kløver	V 11	150	0,0 0,0
18	30	21	2 NT	V 10	180	-3,0 3,0
8	11	40	2 NT	Ø 11	210	-5,0 5,0
6	9	42	1 NT	V 12	240	-7,0 7,0
15	33	18	2 Spar	D S 6	300	-10,0 10,0
5	43	8	2 Spar	D N 6	300	-10,0 10,0
2	3	5	3 NT	V 9	400	-15,0 15,0
3	6	2	3 NT	Ø 9	400	-15,0 15,0
1	44	4	3 NT	V 9	400	-15,0 15,0
17	31	20	3 NT	Ø 10	430	-20,0 20,0
10	38	13	3 NT	V 10	430	-20,0 20,0

SPILLSTENSILER NM Damer, 03. august 2010

♠ 8 Mappen: 9(9)
 ♥ J864 Rundenr: 5
 ♦ QT62 ØV (N)
 ♣ KQT4

♠ K5432
 ♥ KQ95
 ♦ K
 ♣ A65

♠ Q9
 ♥ 32
 ♦ A984
 ♣ J9872

♠ AJT76
 ♥ AT7
 ♦ J753
 ♣ 3

♠ QJ94 Mappen: 11(11)
 ♥ KQT2 Rundenr: 6
 ♦ A73 I (S)
 ♣ Q2

♠ 832
 ♥ A543
 ♦ T5
 ♣ AJT5

♠ AT65
 ♥ 98
 ♦ Q984
 ♣ 64

♠ K7
 ♥ J76
 ♦ KJ6
 ♣ K9873

Bord	NS	ØV		NS	ØV	NS	ØV
7	42	11	2 Spar	V 6	200	20,0	-20,0
21	25	28	3 Spar	V 7	200	20,0	-20,0
2	4	6	2 Ruter	S 9	110	17,0	-17,0
3	7	3	2 Spar	V 7	100	14,0	-14,0
16	33	20	2 Spar	V 7	100	14,0	-14,0
5	1	9	1 NT	N 7	90	8,0	-8,0
15	34	19	2 Ruter	S 8	90	8,0	-8,0
17	32	21	2 Ruter	S 8	90	8,0	-8,0
1	44	5	2 Ruter	S 8	90	8,0	-8,0
19	23	30	2 Ruter	S 7	50	-3,0	3,0
4	8	2	2 Ruter	S 7	50	-3,0	3,0
14	35	18	3 Ruter	S 8	50	-3,0	3,0
12	37	16	3 Ruter	S 8	50	-3,0	3,0
10	39	14	3 Ruter	S 8	50	-3,0	3,0
20	24	29	3 Ruter	S 8	50	-3,0	3,0
9	13	40	3 Ruter	S 8	50	-3,0	3,0
18	31	22	1 NT	N 5	100	-14,0	14,0
6	10	43	2 Ruter	N 6	100	-14,0	14,0
8	12	41	2 Spar	S 6	100	-14,0	14,0
13	17	36	3 Ruter	S 7	100	-14,0	14,0
22	27	26	2 NT	Ø 8	120	-19,0	19,0
11	38	15	1 NT	N 4	150	-21,0	21,0

Bord	NS	ØV		NS	ØV	NS	ØV
20	25	30	3 NT	S 10	430	17,0	-17,0
5	2	10	3 NT	S 10	430	17,0	-17,0
19	24	31	3 NT	S 10	430	17,0	-17,0
15	35	20	3 NT	N 10	430	17,0	-17,0
1	44	6	3 NT	N 10	430	17,0	-17,0
17	33	22	3 NT	S 9	400	0,0	0,0
12	38	17	3 NT	S 9	400	0,0	0,0
22	28	27	3 NT	S 9	400	0,0	0,0
18	32	23	3 NT	S 9	400	0,0	0,0
13	18	37	3 NT	N 9	400	0,0	0,0
16	34	21	3 NT	S 9	400	0,0	0,0
8	13	42	3 NT	S 9	400	0,0	0,0
9	14	41	3 NT	S 9	400	0,0	0,0
21	26	29	3 NT	N 9	400	0,0	0,0
10	40	15	3 NT	S 9	400	0,0	0,0
11	39	16	3 NT	S 9	400	0,0	0,0
2	5	7	3 NT	S 9	400	0,0	0,0
4	9	3	2 NT	N 10	180	-15,0	15,0
6	11	1	2 NT	S 10	180	-15,0	15,0
14	36	19	2 NT	S 10	180	-15,0	15,0
3	8	4	3 NT	S 8	50	-19,0	19,0
7	43	12	3 NT	N 7	100	-21,0	21,0

♠ AKQJ73 Mappen: 10(10)
 ♥ 6 Rundenr: 5
 ♦ T5 A (Ø)
 ♣ A952

♠ 9542
 ♥ Q852
 ♦ Q43
 ♣ J4

♠ T8
 ♥ AT3
 ♦ J9872
 ♣ Q87

♠ 6
 ♥ KJ974
 ♦ AK6
 ♣ KT63

♠ Q6 Mappen: 12(12)
 ♥ Q8762 Rundenr: 6
 ♦ A65 NS (V)
 ♣ Q52

♠ AK72
 ♥ T53
 ♦ KJ987
 ♣ 4

♠ J984
 ♥ J4
 ♦ T4
 ♣ AJT96

♠ T53
 ♥ AK9
 ♦ Q32
 ♣ K873

Bord	NS	ØV		NS	ØV	NS	ØV
5	1	9	6 NT	S 12	1440	21,0	-21,0
8	12	41	6 Spar	N 12	1430	19,0	-19,0
12	37	16	3 NT	S 12	690	17,0	-17,0
15	34	19	4 Spar	N 12	680	12,0	-12,0
10	39	14	4 Spar	N 12	680	12,0	-12,0
19	23	30	4 Spar	N 12	680	12,0	-12,0
4	8	2	4 Spar	N 12	680	12,0	-12,0
6	10	43	3 NT	N 11	660	4,0	-4,0
9	13	40	3 NT	S 11	660	4,0	-4,0
14	35	18	3 NT	S 11	660	4,0	-4,0
22	27	26	3 NT	S 11	660	4,0	-4,0
21	25	28	4 Spar	N 11	650	-7,0	7,0
11	38	15	4 Spar	N 11	650	-7,0	7,0
17	32	21	4 Spar	N 11	650	-7,0	7,0
7	42	11	4 Spar	N 11	650	-7,0	7,0
18	31	22	4 Spar	N 11	650	-7,0	7,0
16	33	20	4 Spar	N 11	650	-7,0	7,0
20	24	29	4 Spar	N 11	650	-7,0	7,0
3	7	3	5 Kløver	S 11	600	-15,0	15,0
2	4	6	6 Kløver	S 11	100	-19,0	19,0
1	44	5	6 Kløver	S 11	100	-19,0	19,0
13	17	36	6 Kløver	S 11	100	-19,0	19,0

Bord	NS	ØV		NS	ØV	NS	ØV
11	39	16	1 Hjarter	N 8	110	21,0	-21,0
8	13	42	2 Hjarter	N 7	100	16,0	-16,0
1	44	6	3 Hjarter	N 8	100	16,0	-16,0
21	26	29	3 Hjarter	N 8	100	16,0	-16,0
18	32	23	3 Hjarter	N 8	100	16,0	-16,0
14	36	19	2 Spar	Ø 8	110	11,0	-11,0
6	11	1	2 Spar	Ø 9	140	6,0	-6,0
22	28	27	2 Spar	Ø 9	140	6,0	-6,0
5	2	10	2 Spar	Ø 9	140	6,0	-6,0
16	34	21	2 Spar	Ø 9	140	6,0	-6,0
3	8	4	2 Spar	Ø 10	170	-5,0	5,0
12	38	17	2 Spar	Ø 10	170	-5,0	5,0
20	25	30	2 Spar	Ø 10	170	-5,0	5,0
10	40	15	2 Spar	Ø 10	170	-5,0	5,0
19	24	31	3 Spar	Ø 10	170	-5,0	5,0
9	14	41	3 Spar	Ø 10	170	-5,0	5,0
15	35	20	3 Spar	Ø 10	170	-5,0	5,0
2	5	7	3 Hjarter	N 7	200	-15,0	15,0
17	33	22	3 Hjarter	N 7	200	-15,0	15,0
13	18	37	3 Hjarter	N 7	200	-15,0	15,0
4	9	3	4 Hjarter	N 7	300	-19,0	19,0
7	43	12	3 Hjarter	D N 7	500	-21,0	21,0

SPILLSTENSILER NM Damer, 03. august 2010

♠ T754 Mappen: 13(13)
 ♥ JT9 Rundrenn: 7
 ♦ QJ3 A (N)
 ♣ Q72

♠ Q9832
 ♥ Q
 ♦ K86
 ♣ KJ96

♠ 6
 ♥ A87653
 ♦ AT4
 ♣ A54

Bord	NS	ØV		NS	ØV	NS	ØV
18	33	24	3 Spar	V 7	200	21,0	-21,0
19	25	32	3 Hjerter	S 9	140	17,0	-17,0
21	27	30	3 Hjerter	S 9	140	17,0	-17,0
5	3	11	3 Hjerter	S 9	140	17,0	-17,0
1	44	7	2 Spar	V 7	100	10,0	-10,0
15	36	21	3 Spar	V 8	100	10,0	-10,0
8	14	43	3 Spar	V 8	100	10,0	-10,0
20	26	31	3 Spar	V 8	100	10,0	-10,0
13	19	38	2 Spar	S 7	100	2,0	-2,0
7	1	13	3 Hjerter	S 8	100	2,0	-2,0
2	6	8	3 Hjerter	S 8	100	2,0	-2,0
22	29	28	3 Hjerter	S 8	100	2,0	-2,0
17	34	23	2 Spar	V 8	110	-4,0	4,0
12	39	18	2 Spar	V 8	110	-4,0	4,0
16	35	22	2 Spar	V 9	140	-13,0	13,0
6	12	2	3 Spar	V 9	140	-13,0	13,0
9	15	42	3 Spar	V 9	140	-13,0	13,0
11	40	17	3 Spar	V 9	140	-13,0	13,0
10	41	16	3 Spar	V 9	140	-13,0	13,0
3	9	5	3 Spar	V 9	140	-13,0	13,0
14	37	20	3 Spar	V 9	140	-13,0	13,0
4	10	4	4 Hjerter	D S 9	200	-21,0	21,0

♠ 872 Mappen: 15(15)
 ♥ 9752 Rundrenn: 8
 ♦ Q9 NS (S)
 ♣ A982

♠ AKQ
 ♥ 6
 ♦ J85432
 ♣ KJ4

♠ 96543
 ♥ T8
 ♦ AKT6
 ♣ 65

Bord	NS	ØV		NS	ØV	NS	ØV
13	20	39	3 NT	V 9	400	21,0	-21,0
2	7	9	3 NT	V 10	430	16,0	-16,0
5	4	12	3 NT	V 10	430	16,0	-16,0
19	26	33	3 NT	V 10	430	16,0	-16,0
21	28	31	3 NT	V 10	430	16,0	-16,0
18	34	25	4 Hjerter	Ø 11	450	5,0	-5,0
16	36	23	4 Hjerter	Ø 11	450	5,0	-5,0
4	11	5	4 Hjerter	Ø 11	450	5,0	-5,0
22	30	29	4 Hjerter	Ø 11	450	5,0	-5,0
8	15	1	4 Hjerter	Ø 11	450	5,0	-5,0
14	38	21	4 Hjerter	Ø 11	450	5,0	-5,0
11	41	18	4 Hjerter	Ø 11	450	5,0	-5,0
17	35	24	4 Hjerter	Ø 12	480	-7,0	7,0
6	13	3	4 Hjerter	Ø 12	480	-7,0	7,0
10	42	17	4 Hjerter	Ø 12	480	-7,0	7,0
20	27	32	4 Hjerter	Ø 12	480	-7,0	7,0
1	44	8	4 Hjerter	V 12	480	-7,0	7,0
3	10	6	3 NT	V 12	490	-17,0	17,0
7	2	14	3 NT	V 12	490	-17,0	17,0
15	37	22	3 NT	Ø 12	490	-17,0	17,0
9	16	43	3 NT	V 12	490	-17,0	17,0
12	40	19	3 NT	Ø 12	490	-17,0	17,0

♠ A754 Mappen: 14(14)
 ♥ AKJT7 Rundrenn: 7
 ♦ QT6 I (Ø)
 ♣ J

♠ JT8
 ♥ 2
 ♦ KJ75
 ♣ KQT87

♠ K632
 ♥ 984
 ♦ 9832
 ♣ A9

Bord	NS	ØV		NS	ØV	NS	ØV
8	14	43	4 Spar	N 10	420	21,0	-21,0
1	44	7	5 Kløver	D V 9	300	19,0	-19,0
13	19	38	2 Spar	S 9	140	13,0	-13,0
12	39	18	2 Spar	S 9	140	13,0	-13,0
9	15	42	3 Spar	S 9	140	13,0	-13,0
16	35	22	3 Spar	S 9	140	13,0	-13,0
17	34	23	3 Spar	S 9	140	13,0	-13,0
15	36	21	2 Hjerter	N 8	110	7,0	-7,0
11	40	17	3 Hjerter	N 8	50	-2,0	2,0
20	26	31	3 Hjerter	N 8	50	-2,0	2,0
3	9	5	3 Hjerter	N 8	50	-2,0	2,0
14	37	20	3 Hjerter	N 8	50	-2,0	2,0
22	29	28	3 Hjerter	N 8	50	-2,0	2,0
5	3	11	3 Hjerter	N 8	50	-2,0	2,0
10	41	16	4 Spar	S 9	50	-2,0	2,0
7	1	13	4 Spar	S 9	50	-2,0	2,0
19	25	32	3 Hjerter	N 7	100	-14,0	14,0
2	6	8	3 Spar	S 7	100	-14,0	14,0
21	27	30	4 Hjerter	N 8	100	-14,0	14,0
18	33	24	4 Spar	N 8	100	-14,0	14,0
6	12	2	3 Kløver	Ø 9	110	-19,0	19,0
4	10	4	3 Kløver	D V 9	470	-21,0	21,0

♠ AT874 Mappen: 16(16)
 ♥ 7 Rundrenn: 8
 ♦ 2 ØV (V)
 ♣ AQT543

♠ 96
 ♥ KJ9853
 ♦ AJ4
 ♣ 87

♠ QJ
 ♥ AQT4
 ♦ 653
 ♣ J962

Bord	NS	ØV		NS	ØV	NS	ØV
7	2	14	3 NT	S 11	460	21,0	-21,0
15	37	22	4 Spar	N 11	450	18,0	-18,0
13	20	39	4 Spar	N 11	450	18,0	-18,0
22	30	29	5 Kløver	N 11	400	15,0	-15,0
18	34	25	2 Spar	N 11	200	10,0	-10,0
10	42	17	2 Spar	N 11	200	10,0	-10,0
9	16	43	2 Spar	N 11	200	10,0	-10,0
21	28	31	2 Spar	N 11	200	10,0	-10,0
19	26	33	4 Kløver	N 10	130	5,0	-5,0
3	10	6	5 Ruter	V 10	100	3,0	-3,0
11	41	18	3 NT	S 8	50	-1,0	1,0
4	11	5	5 Kløver	S 10	50	-1,0	1,0
17	35	24	5 Kløver	N 10	50	-1,0	1,0
2	7	9	2 Spar	N 6	100	-6,0	6,0
1	44	8	4 Spar	N 8	100	-6,0	6,0
6	13	3	3 Hjerter	Ø 9	140	-9,0	9,0
14	38	21	2 Spar	N 5	150	-11,0	11,0
20	27	32	2 Hjerter	V 10	170	-13,0	13,0
5	4	12	4 Spar	N 6	200	-15,0	15,0
16	36	23	4 Spar	N 5	250	-17,0	17,0
12	40	19	6 Kløver	D S 10	300	-19,0	19,0
8	15	1	2 Hjerter	D V 9	870	-21,0	21,0

SPILLSTENSILER NM Damer, 03. august 2010

♠ KT965 Mappen: 17(17)
 ♥ A62 Rundenr: 9
 ♦ 62 I (N)
 ♣ AK9

♠ T43 Mappen: 19(19)
 ♥ AQJ97 Rundenr: 10
 ♦ 753 ØV (S)
 ♣ 85

Bord	NS	ØV		NS	ØV	NS	ØV
7	3	15	3 Hjerter	D Ø 7	300	21,0	-21,0
14	39	22	1 NT	S 7	90	16,0	-16,0
11	42	19	1 NT	S 7	90	16,0	-16,0
16	37	24	1 NT	S 7	90	16,0	-16,0
5	5	13	1 NT	N 7	90	16,0	-16,0
15	38	23	2 Hjerter	V 7	50	7,0	-7,0
22	31	30	2 Kløver	Ø 7	50	7,0	-7,0
2	8	10	2 NT	Ø 7	50	7,0	-7,0
18	35	26	3 Hjerter	V 8	50	7,0	-7,0
19	27	34	3 Hjerter	V 8	50	7,0	-7,0
3	11	7	2 NT	S 7	50	0,0	0,0
6	14	4	2 Spar	N 7	50	0,0	0,0
12	41	20	2 NT	N 6	100	-5,0	5,0
9	17	1	2 Spar	S 6	100	-5,0	5,0
4	12	6	2 Spar	D N 7	100	-5,0	5,0
10	43	18	2 Hjerter	V 8	110	-13,0	13,0
17	36	25	2 Hjerter	V 8	110	-13,0	13,0
13	21	40	2 Hjerter	Ø 8	110	-13,0	13,0
8	16	2	2 Hjerter	V 8	110	-13,0	13,0
20	28	33	2 Hjerter	V 8	110	-13,0	13,0
21	29	32	2 Hjerter	V 9	140	-20,0	20,0
1	44	9	3 Hjerter	V 9	140	-20,0	20,0

Bord	NS	ØV		NS	ØV	NS	ØV
14	40	23	3 NT	S 11	460	21,0	-21,0
9	18	2	3 NT	S 9	400	14,0	-14,0
4	13	7	3 NT	S 9	400	14,0	-14,0
22	32	31	3 NT	S 9	400	14,0	-14,0
18	36	27	3 NT	S 9	400	14,0	-14,0
21	30	33	3 NT	S 9	400	14,0	-14,0
11	43	20	3 NT	S 9	400	14,0	-14,0
2	9	11	1 Spar	S 10	170	6,0	-6,0
10	1	19	2 Spar	S 10	170	6,0	-6,0
7	4	16	2 NT	S 9	150	1,0	-1,0
3	12	8	2 NT	S 9	150	1,0	-1,0
12	42	21	2 NT	S 9	150	1,0	-1,0
1	44	10	2 Hjerter	S 9	140	-5,0	5,0
17	37	26	3 Hjerter	N 9	140	-5,0	5,0
13	22	41	3 Spar	S 9	140	-5,0	5,0
6	15	5	1 NT	N 8	120	-11,0	11,0
15	39	24	2 NT	S 8	120	-11,0	11,0
16	38	25	2 NT	N 8	120	-11,0	11,0
19	28	35	3 NT	S 8	50	-18,0	18,0
5	6	14	3 NT	N 8	50	-18,0	18,0
8	17	3	3 NT	S 8	50	-18,0	18,0
20	29	34	3 NT	N 8	50	-18,0	18,0

♠ JT32 Mappen: 18(18)
 ♥ Q82 Rundenr: 9
 ♦ AJ NS (Ø)
 ♣ AK98

♠ J6 Mappen: 20(20)
 ♥ J943 Rundenr: 10
 ♦ 432 A (V)
 ♣ AK52

Bord	NS	ØV		NS	ØV	NS	ØV
5	5	13	3 Ruter	D S 11	1070	21,0	-21,0
4	12	6	3 NT	N 12	690	19,0	-19,0
2	8	10	5 Ruter	S 12	620	17,0	-17,0
12	41	20	5 Ruter	S 11	600	12,0	-12,0
3	11	7	5 Ruter	S 11	600	12,0	-12,0
10	43	18	5 Ruter	S 11	600	12,0	-12,0
13	21	40	5 Ruter	S 11	600	12,0	-12,0
9	17	1	4 Spar	D V 8	300	7,0	-7,0
1	44	9	4 Hjerter	Ø 9	50	4,0	-4,0
20	28	33	4 Spar	Ø 9	50	4,0	-4,0
15	38	23	5 Ruter	S 10	100	1,0	-1,0
19	27	34	3 Spar	Ø 10	170	-2,0	2,0
22	31	30	3 Spar	Ø 10	170	-2,0	2,0
6	14	4	4 Hjerter	Ø 10	420	-7,0	7,0
8	16	2	4 Spar	Ø 10	420	-7,0	7,0
14	39	22	4 Spar	V 10	420	-7,0	7,0
18	35	26	4 Hjerter	D Ø 10	590	-16,0	16,0
17	36	25	4 Spar	D Ø 10	590	-16,0	16,0
21	29	32	4 Spar	D Ø 10	590	-16,0	16,0
7	3	15	4 Spar	D Ø 10	590	-16,0	16,0
11	42	19	4 Spar	D Ø 10	590	-16,0	16,0
16	37	24	4 Spar	D Ø 10	590	-16,0	16,0

Bord	NS	ØV		NS	ØV	NS	ØV
17	37	26	3 NT	V 8	100	19,0	-19,0
16	38	25	3 NT	V 8	100	19,0	-19,0
4	13	7	3 Ruter	Ø 8	100	19,0	-19,0
15	39	24	1 NT	Ø 7	90	15,0	-15,0
18	36	27	2 Spar	N 7	100	13,0	-13,0
9	18	2	1 NT	V 8	120	4,0	-4,0
21	30	33	1 NT	V 8	120	4,0	-4,0
11	43	20	1 NT	V 8	120	4,0	-4,0
22	32	31	1 NT	V 8	120	4,0	-4,0
12	42	21	1 NT	V 8	120	4,0	-4,0
20	29	34	1 NT	V 8	120	4,0	-4,0
14	40	23	1 NT	V 8	120	4,0	-4,0
7	4	16	2 NT	V 8	120	4,0	-4,0
19	28	35	1 NT	V 9	150	-6,0	6,0
2	9	11	1 NT	V 9	150	-6,0	6,0
3	12	8	1 NT	D V 8	380	-9,0	9,0
13	22	41	3 NT	Ø 9	600	-16,0	16,0
1	44	10	3 NT	Ø 9	600	-16,0	16,0
8	17	3	3 NT	Ø 9	600	-16,0	16,0
10	1	19	3 NT	Ø 9	600	-16,0	16,0
6	15	5	3 NT	Ø 9	600	-16,0	16,0
5	6	14	3 NT	Ø 9	600	-16,0	16,0

SPILLSTENSILER NM Damer, 03. august 2010

♠ A42 Mappen: 21(21)
♥ K8 Rundennr: 11
♦ AKQJ5 NS (N)

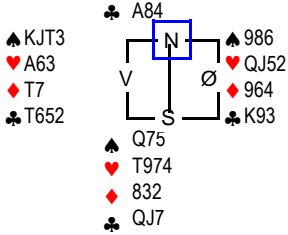

Bord	NS	ØV		NS	ØV	NS	ØV
1	44	11	3NT	N 10	630	21,0	-21,0
3	13	9	3NT	N 9	600	6,0	-6,0
6	16	6	3NT	N 9	600	6,0	-6,0
10	2	20	3NT	N 9	600	6,0	-6,0
5	7	15	3NT	N 9	600	6,0	-6,0
16	39	26	3NT	N 9	600	6,0	-6,0
17	38	27	3NT	N 9	600	6,0	-6,0
8	18	4	3NT	N 9	600	6,0	-6,0
18	37	28	3NT	N 9	600	6,0	-6,0
15	40	25	3NT	N 9	600	6,0	-6,0
22	33	32	3NT	N 9	600	6,0	-6,0
20	30	35	3NT	N 9	600	6,0	-6,0
12	43	22	3NT	N 9	600	6,0	-6,0
11	1	21	3NT	S 9	600	6,0	-6,0
14	41	24	3NT	N 9	600	6,0	-6,0
13	23	42	3NT	N 8	100	-14,0	14,0
21	31	34	3NT	N 8	100	-14,0	14,0
9	19	3	3NT	N 8	100	-14,0	14,0
7	5	17	3NT	N 8	100	-14,0	14,0
19	29	36	3NT	N 8	100	-14,0	14,0
4	14	8	3NT	N 8	100	-14,0	14,0
2	10	12	3NT	N 7	200	-21,0	21,0

♠ T872 Mappen: 23(23)
♥ K98 Rundennr: 12
♦ AQ A (S)

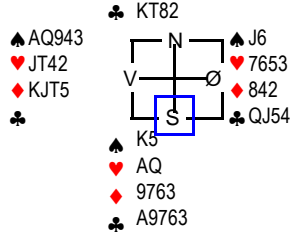

Bord	NS	ØV		NS	ØV	NS	ØV
15	41	26	3NT	S 10	630	19,0	-19,0
21	32	35	3NT	S 10	630	19,0	-19,0
20	31	36	3NT	S 10	630	19,0	-19,0
7	6	18	3NT	N 9	600	11,0	-11,0
13	24	43	3NT	S 9	600	11,0	-11,0
22	34	33	3NT	S 9	600	11,0	-11,0
1	44	12	3NT	S 9	600	11,0	-11,0
11	2	22	3NT	S 9	600	11,0	-11,0
5	16	8	2 Hjerter	V 5	300	5,0	-5,0
12	1	23	2 Spar	V 6	200	3,0	-3,0
8	19	5	2NT	S 10	180	0,0	0,0
17	39	28	2NT	S 10	180	0,0	0,0
19	30	37	2 Kløver	S 11	150	-7,0	7,0
2	11	13	2NT	S 9	150	-7,0	7,0
14	42	25	2NT	S 9	150	-7,0	7,0
4	15	9	2NT	S 9	150	-7,0	7,0
18	38	29	3 Kløver	S 11	150	-7,0	7,0
6	17	7	4 Kløver	S 10	130	-14,0	14,0
3	14	10	4 Kløver	S 10	130	-14,0	14,0
10	3	21	3NT	S 8	100	-18,0	18,0
16	40	27	3NT	N 8	100	-18,0	18,0
9	20	4	3NT	N 6	300	-21,0	21,0

♠ T654 Mappen: 22(22)
♥ T53 Rundennr: 11
♦ T7653 ØV (Ø)

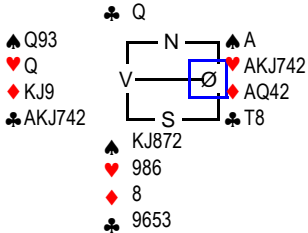

Bord	NS	ØV		NS	ØV	NS	ØV
4	14	8	6 Ruter	Ø 11	100	21,0	-21,0
1	44	11	1 Kløver	V 12	170	19,0	-19,0
15	40	25	4 Hjerter	Ø 13	710	17,0	-17,0
22	33	32	3NT	V 13	720	15,0	-15,0
8	18	4	6 Kløver	V 12	1370	11,0	-11,0
16	39	26	6 Ruter	Ø 12	1370	11,0	-11,0
5	7	15	6 Ruter	Ø 12	1370	11,0	-11,0
14	41	24	6 Hjerter	Ø 13	1460	3,0	-3,0
21	31	34	6 Hjerter	Ø 13	1460	3,0	-3,0
18	37	28	6 Hjerter	Ø 13	1460	3,0	-3,0
9	19	3	6 Hjerter	Ø 13	1460	3,0	-3,0
2	10	12	6 Hjerter	Ø 13	1460	3,0	-3,0
10	2	20	6NT	V 13	1470	-11,0	11,0
19	29	36	6NT	V 13	1470	-11,0	11,0
7	5	17	6NT	V 13	1470	-11,0	11,0
17	38	27	6NT	V 13	1470	-11,0	11,0
3	13	9	6NT	V 13	1470	-11,0	11,0
13	23	42	6NT	V 13	1470	-11,0	11,0
20	30	35	6NT	V 13	1470	-11,0	11,0
12	43	22	6NT	V 13	1470	-11,0	11,0
6	16	6	6NT	Ø 13	1470	-11,0	11,0
11	1	21	7NT	V 13	2220	-21,0	21,0

♠ T98542 Mappen: 24(24)
♥ J4 Rundennr: 12
♦ A72 I (V)

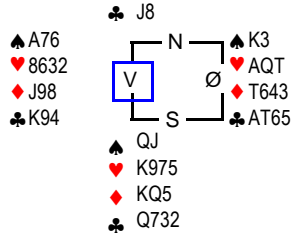

Bord	NS	ØV		NS	ØV	NS	ØV
19	30	37	2 Spar	N 9	140	19,0	-19,0
8	19	5	2 Spar	N 9	140	19,0	-19,0
10	3	21	2 Spar	N 9	140	19,0	-19,0
7	6	18	2 Spar	N 8	110	3,0	-3,0
3	14	10	2 Spar	S 8	110	3,0	-3,0
18	38	29	2 Spar	N 8	110	3,0	-3,0
14	42	25	2 Spar	N 8	110	3,0	-3,0
4	15	9	2 Spar	N 8	110	3,0	-3,0
15	41	26	2 Spar	N 8	110	3,0	-3,0
6	17	7	2 Spar	S 8	110	3,0	-3,0
22	34	33	2 Spar	N 8	110	3,0	-3,0
13	24	43	2 Spar	N 8	110	3,0	-3,0
16	40	27	2 Spar	N 8	110	3,0	-3,0
20	31	36	2 Spar	N 8	110	3,0	-3,0
2	11	13	2 Spar	N 8	110	3,0	-3,0
9	20	4	2 Spar	N 8	110	3,0	-3,0
21	32	35	3 Hjerter	V 7	100	-12,0	12,0
11	2	22	3 Hjerter	V 7	100	-12,0	12,0
1	44	12	1NT	Ø 6	50	-16,0	16,0
12	1	23	1NT	Ø 6	50	-16,0	16,0
5	16	8	1 Hjerter	V 7	80	-19,0	19,0
17	39	28	1 Hjerter	V 8	110	-21,0	21,0

SPILLSTENSILER NM Damer, 03. august 2010

♠ AJ8 Mappen: 25(25)
 ♥ JT3 Rundenr: 13
 ♦ AQ ØV (N)
 ♣ A8752

♠ KQ743
 ♥ AK98
 ♦ K32
 ♣ 9

♠ 92
 ♥ 654
 ♦ JT87
 ♣ JT43

Bord	NS	ØV		NS	ØV	NS	ØV
19	31	38	2 Kløver	V 5	300	20,0	-20,0
4	16	10	2 Kløver	V 5	300	20,0	-20,0
21	33	36	2 Hjerter	V 7	100	15,0	-15,0
14	43	26	3 Hjerter	Ø 8	100	15,0	-15,0
13	25	1	3 Spar	V 8	100	15,0	-15,0
12	2	24	1 NT	N 7	90	11,0	-11,0
11	3	23	3 Kløver	S 7	100	8,0	-8,0
7	7	19	3 Kløver	N 7	100	8,0	-8,0
15	42	27	2 Hjerter	Ø 8	110	2,0	-2,0
6	18	8	2 Hjerter	Ø 8	110	2,0	-2,0
17	40	29	2 Spar	V 8	110	2,0	-2,0
9	21	5	2 Spar	V 8	110	2,0	-2,0
2	12	14	2 Hjerter	Ø 9	140	-10,0	10,0
16	41	28	2 Hjerter	Ø 9	140	-10,0	10,0
20	32	37	2 Hjerter	Ø 9	140	-10,0	10,0
10	4	22	2 Hjerter	Ø 9	140	-10,0	10,0
22	35	34	2 Hjerter	V 9	140	-10,0	10,0
5	9	17	2 Spar	V 9	140	-10,0	10,0
8	20	6	2 Spar	V 9	140	-10,0	10,0
1	44	13	2 Spar	V 9	140	-10,0	10,0
18	39	30	2 Hjerter	Ø 10	170	-20,0	20,0
3	15	11	2 Spar	V 10	170	-20,0	20,0

♠ J86 Mappen: 27(27)
 ♥ KQJ Rundenr: 14
 ♦ 763 I (S)
 ♣ AKT5

♠ Q973
 ♥ A9863
 ♦ K4
 ♣ 62

♠ AT2
 ♥ 42
 ♦ J952
 ♣ 8743

Bord	NS	ØV		NS	ØV	NS	ØV
6	19	9	1 NT	N 7	90	20,0	-20,0
20	33	38	1 NT	N 7	90	20,0	-20,0
7	8	20	1 NT	Ø 6	50	9,0	-9,0
12	3	25	1 NT	Ø 6	50	9,0	-9,0
3	16	12	1 NT	V 6	50	9,0	-9,0
14	1	27	2 Hjerter	V 7	50	9,0	-9,0
10	5	23	2 Hjerter	V 7	50	9,0	-9,0
1	44	14	2 Hjerter	V 7	50	9,0	-9,0
5	10	18	3 Hjerter	V 8	50	9,0	-9,0
18	40	31	3 Hjerter	V 8	50	9,0	-9,0
4	17	11	4 Hjerter	V 9	50	9,0	-9,0
11	4	24	1 NT	N 6	50	-1,0	1,0
9	22	6	3 Kløver	N 7	100	-4,0	4,0
17	41	30	3 Kløver	N 7	100	-4,0	4,0
15	43	28	1 Hjerter	V 8	110	-11,0	11,0
8	21	7	2 Hjerter	V 8	110	-11,0	11,0
22	36	35	2 Hjerter	V 8	110	-11,0	11,0
2	13	15	2 Hjerter	V 8	110	-11,0	11,0
19	32	39	2 Hjerter	V 8	110	-11,0	11,0
13	26	2	1 NT	Ø 8	120	-17,0	17,0
16	42	29	2 Hjerter	V 9	140	-19,0	19,0
21	34	37	3 Kløver	D N 7	300	-21,0	21,0

♠ 86 Mappen: 26(26)
 ♥ Q6 Rundenr: 13
 ♦ AQ98 A (Ø)
 ♣ J9752

♠ QT72
 ♥ J954
 ♦ JT6
 ♣ Q3

♠ KJ5
 ♥ AK32
 ♦ 32
 ♣ AKT8

Bord	NS	ØV		NS	ØV	NS	ØV
17	40	29	3 NT	S 11	660	18,0	-18,0
22	35	34	3 NT	S 11	660	18,0	-18,0
16	41	28	3 NT	S 11	660	18,0	-18,0
20	32	37	3 NT	S 11	660	18,0	-18,0
2	12	14	3 NT	S 10	630	3,0	-3,0
7	7	19	3 NT	S 10	630	3,0	-3,0
9	21	5	3 NT	S 10	630	3,0	-3,0
5	9	17	3 NT	S 10	630	3,0	-3,0
15	42	27	3 NT	S 10	630	3,0	-3,0
18	39	30	3 NT	S 10	630	3,0	-3,0
11	3	23	3 NT	N 10	630	3,0	-3,0
4	16	10	3 NT	S 10	630	3,0	-3,0
19	31	38	3 NT	N 10	630	3,0	-3,0
21	33	36	3 NT	N 10	630	3,0	-3,0
6	18	8	3 NT	S 10	630	3,0	-3,0
14	43	26	3 NT	N 9	600	-13,0	13,0
12	2	24	3 NT	S 9	600	-13,0	13,0
13	25	1	3 NT	S 9	600	-13,0	13,0
3	15	11	3 NT	S 9	600	-13,0	13,0
1	44	13	3 NT	S 9	600	-13,0	13,0
8	20	6	3 Kløver	S 11	150	-19,0	19,0
10	4	22	6 Kløver	S 11	100	-21,0	21,0

♠ K753 Mappen: 28(28)
 ♥ AQ4 Rundenr: 14
 ♦ Q43 NS (V)
 ♣ AJ7

♠ A94
 ♥ J865
 ♦ 8
 ♣ QT965

♠ T8
 ♥ KT932
 ♦ JT976
 ♣ 4

Bord	NS	ØV		NS	ØV	NS	ØV
4	17	11	2 Hjerter	D N 9	870	21,0	-21,0
16	42	29	3 NT	N 9	600	19,0	-19,0
1	44	14	2 Hjerter	N 10	170	17,0	-17,0
20	33	38	2 Hjerter	N 9	140	0,0	0,0
19	32	39	2 Hjerter	N 9	140	0,0	0,0
7	8	20	2 Hjerter	N 9	140	0,0	0,0
5	10	18	2 Hjerter	N 9	140	0,0	0,0
12	3	25	2 Hjerter	N 9	140	0,0	0,0
11	4	24	2 Hjerter	N 9	140	0,0	0,0
15	43	28	2 Hjerter	N 9	140	0,0	0,0
9	22	6	2 Hjerter	N 9	140	0,0	0,0
14	1	27	2 Hjerter	N 9	140	0,0	0,0
10	5	23	2 Hjerter	N 9	140	0,0	0,0
22	36	35	2 Hjerter	N 9	140	0,0	0,0
17	41	30	2 Hjerter	N 9	140	0,0	0,0
21	34	37	2 Hjerter	N 9	140	0,0	0,0
18	40	31	2 Hjerter	N 9	140	0,0	0,0
2	13	15	2 Hjerter	N 9	140	0,0	0,0
3	16	12	3 Hjerter	N 9	140	0,0	0,0
8	21	7	2 Hjerter	N 8	110	-17,0	17,0
6	19	9	3 Kløver	V 8	50	-19,0	19,0
13	26	2	4 Hjerter	S 9	100	-21,0	21,0

SPILLSTENSILER NM Damer, 03. august 2010

♠ 4 Mappen: 29(29)
 ♥ AT96 Rundennr: 15
 ♦ QT8 A (N)
 ♣ A9652

♠ AT96
 ♥ 543
 ♦ A65
 ♣ QJ3

♠ K852
 ♥ KQ
 ♦ KJ942
 ♣ K7

Bord	NS	ØV	NS	ØV	NS	ØV
3	17	13	3NT	S 12	690	21,0 -21,0
9	23	7	3NT	S 11	660	18,0 -18,0
5	11	19	3NT	S 11	660	18,0 -18,0
15	1	29	3NT	S 10	630	8,0 -8,0
8	22	8	3NT	S 10	630	8,0 -8,0
13	27	3	3NT	S 10	630	8,0 -8,0
4	18	12	3NT	S 10	630	8,0 -8,0
11	5	25	3NT	S 10	630	8,0 -8,0
21	35	38	3NT	S 10	630	8,0 -8,0
2	14	16	3NT	S 10	630	8,0 -8,0
20	34	39	3NT	S 10	630	8,0 -8,0
12	4	26	3NT	S 9	600	-5,0 5,0
18	41	32	3NT	S 9	600	-5,0 5,0
17	42	31	3NT	S 9	600	-5,0 5,0
22	37	36	3NT	S 9	600	-5,0 5,0
14	2	28	3NT	S 9	600	-5,0 5,0
16	43	30	2NT	S 12	240	-11,0 11,0
7	9	21	1NT	N 11	210	-13,0 13,0
1	44	15	1NT	N 10	180	-15,0 15,0
19	33	40	1NT	N 9	150	-17,0 17,0
10	6	24	1NT	N 8	120	-19,0 19,0
6	20	10	3NT	S 7	200	-21,0 21,0

♠ KT8 Mappen: 31(31)
 ♥ KQ643 Rundennr: 16
 ♦ KQ NS (S)
 ♣ A74

♠ J93
 ♥ 9
 ♦ J74
 ♣ KQ9862

♠ A7654
 ♥ AT
 ♦ A965
 ♣ J5

Bord	NS	ØV	NS	ØV	NS	ØV
2	15	17	6 Spar	S 12	1430	17,0 -17,0
8	23	9	6 Spar	S 12	1430	17,0 -17,0
17	43	32	6 Spar	S 12	1430	17,0 -17,0
18	42	33	6 Spar	S 12	1430	17,0 -17,0
12	5	27	6 Spar	S 12	1430	17,0 -17,0
5	20	12	4 Spar	S 13	710	11,0 -11,0
21	36	39	4 Spar	S 12	680	3,0 -3,0
9	24	8	4 Spar	S 12	680	3,0 -3,0
13	28	4	4 Spar	S 12	680	3,0 -3,0
4	19	13	4 Spar	S 12	680	3,0 -3,0
16	1	31	4 Spar	S 12	680	3,0 -3,0
11	6	26	5 Spar	S 12	680	3,0 -3,0
20	35	40	5 Spar	S 12	680	3,0 -3,0
19	34	41	4 Spar	S 11	650	-5,0 5,0
22	38	37	3NT	S 9	600	-7,0 7,0
7	10	22	6 Spar	S 11	100	-13,0 13,0
6	21	11	6 Spar	S 11	100	-13,0 13,0
1	44	16	6 Spar	N 11	100	-13,0 13,0
10	7	25	6 Spar	S 11	100	-13,0 13,0
15	2	30	6 Spar	S 11	100	-13,0 13,0
3	18	14	7 Spar	S 11	200	-19,0 19,0
14	3	29	7NT	N 9	400	-21,0 21,0

♠ AQ7 Mappen: 30(30)
 ♥ T986 Rundennr: 15
 ♦ 2 I (Ø)
 ♣ AKQ98

♠ K52
 ♥ AQ2
 ♦ AJ765
 ♣ 65

♠ JT94
 ♥ J7
 ♦ K98
 ♣ JT74

Bord	NS	ØV	NS	ØV	NS	ØV
5	11	19	2NT	D V 5	500	21,0 -21,0
21	35	38	3NT	S 10	430	17,0 -17,0
18	41	32	3NT	S 10	430	17,0 -17,0
7	9	21	3NT	S 10	430	17,0 -17,0
11	5	25	4 Spar	S 10	420	13,0 -13,0
10	6	24	3 Spar	S 11	200	11,0 -11,0
9	23	7	2 Spar	S 10	170	7,0 -7,0
12	4	26	3 Spar	S 10	170	7,0 -7,0
19	33	40	3 Spar	S 10	170	7,0 -7,0
1	44	15	1NT	V 4	150	2,0 -2,0
8	22	8	2NT	S 9	150	2,0 -2,0
20	34	39	3 Spar	S 9	140	-3,0 3,0
2	14	16	3 Spar	S 9	140	-3,0 3,0
6	20	10	3 Spar	S 9	140	-3,0 3,0
17	42	31	2 Kløver	N 10	130	-9,0 9,0
22	37	36	4 Kløver	N 10	130	-9,0 9,0
14	2	28	4 Kløver	N 10	130	-9,0 9,0
16	43	30	3 Ruter	V 8	50	-15,0 15,0
3	17	13	3 Ruter	V 8	50	-15,0 15,0
4	18	12	3 Ruter	V 8	50	-15,0 15,0
13	27	3	3 Ruter	V 9	110	-19,0 19,0
15	1	29	3 Ruter	D V 10	570	-21,0 21,0

♠ 876542 Mappen: 32(32)
 ♥ A9754 Rundennr: 16
 ♦ Q5 ØV (V)
 ♣

♠ Q
 ♥ QT6
 ♦ A842
 ♣ AK632

♠ J9
 ♥ J3
 ♦ JT7
 ♣ JT8754

Bord	NS	ØV	NS	ØV	NS	ØV
9	24	8	6 Kløver	V 9	300	21,0 -21,0
17	43	32	6NT	V 10	200	18,0 -18,0
11	6	26	6 Ruter	Ø 10	200	18,0 -18,0
5	20	12	2 Spar	D N 5	500	15,0 -15,0
15	2	30	3NT	Ø 10	630	10,0 -10,0
20	35	40	3NT	Ø 10	630	10,0 -10,0
18	42	33	3NT	Ø 10	630	10,0 -10,0
12	5	27	3NT	Ø 10	630	10,0 -10,0
8	23	9	3NT	Ø 11	660	-3,0 3,0
21	36	39	3NT	V 11	660	-3,0 3,0
4	19	13	3NT	V 11	660	-3,0 3,0
2	15	17	3NT	Ø 11	660	-3,0 3,0
1	44	16	3NT	Ø 11	660	-3,0 3,0
7	10	22	3NT	Ø 11	660	-3,0 3,0
10	7	25	3NT	Ø 11	660	-3,0 3,0
3	18	14	3NT	Ø 11	660	-3,0 3,0
6	21	11	4NT	Ø 11	660	-3,0 3,0
22	38	37	3NT	V 12	690	-15,0 15,0
19	34	41	3NT	V 12	690	-15,0 15,0
16	1	31	3NT	Ø 12	690	-15,0 15,0
14	3	29	4 Spar	D S 6	800	-19,0 19,0
13	28	4	4 Spar	D N 4	1400	-21,0 21,0

SPILLSTENSILER NM Damer, 03. august 2010

♠ 3 Mappen: 1(33)
 ♥ 987 Rundenr: 17
 ♦ J9875 I (N)
 ♣ 9752

♠ T KJ98654
 ♥ KJ64 Q52
 ♦ AKT2 43
 ♣ KT64 J

♠ AQ72
 ♥ AT3
 ♦ Q6
 ♣ AQ83

♠ AT52 Mappen: 3(35)
 ♥ K7 Rundenr: 18
 ♦ Q3 ØV (S)
 ♣ Q6543

♠ 763 KJ9
 ♥ AT2 J865
 ♦ KT965 2
 ♣ 98 KJT72

♠ Q84
 ♥ Q943
 ♦ AJ874
 ♣ A

Bord	NS	ØV		NS	ØV	NS	ØV
22	39	38	3 Spar	D Ø 8	100	16,0	-16,0
10	8	26	3 Spar	D Ø 8	100	16,0	-16,0
4	20	14	4 Spar	D Ø 9	100	16,0	-16,0
2	16	18	4 Spar	D Ø 9	100	16,0	-16,0
18	43	34	4 Spar	D Ø 9	100	16,0	-16,0
19	35	42	4 Spar	D Ø 9	100	16,0	-16,0
7	11	23	3 NT	S 7	100	9,0	-9,0
16	2	32	3 Spar	Ø 9	140	6,0	-6,0
3	19	15	3 Spar	Ø 9	140	6,0	-6,0
11	7	27	2 NT	S 5	150	-2,0	2,0
14	4	30	2 NT	S 5	150	-2,0	2,0
20	36	41	3 NT	S 6	150	-2,0	2,0
5	13	21	3 NT	S 6	150	-2,0	2,0
21	37	40	3 NT	S 6	150	-2,0	2,0
9	25	9	4 Ruter	N 7	150	-2,0	2,0
6	22	12	3 NT	D S 6	500	-10,0	10,0
8	24	10	3 NT	D S 6	500	-10,0	10,0
15	3	31	3 Spar	D Ø 9	530	-14,0	14,0
13	29	5	3 Spar	D Ø 9	530	-14,0	14,0
1	44	17	4 Ruter	D N 6	800	-18,0	18,0
17	1	33	5 Klever	D N 7	800	-18,0	18,0
12	6	28	5 NT	D S 6	1100	-21,0	21,0

Bord	NS	ØV		NS	ØV	NS	ØV
8	25	11	2 Hjerter	V 6	200	21,0	-21,0
18	1	35	2 NT	S 10	180	19,0	-19,0
11	8	28	2 Spar	N 9	140	16,0	-16,0
14	5	31	2 Spar	N 9	140	16,0	-16,0
6	23	13	1 NT	S 8	120	12,0	-12,0
5	14	22	2 NT	N 8	120	12,0	-12,0
12	7	29	2 Spar	N 8	110	9,0	-9,0
4	21	15	2 Hjerter	V 7	100	7,0	-7,0
15	4	32	1 NT	S 7	90	5,0	-5,0
22	40	39	2 Ruter	N 7	50	-3,0	3,0
13	30	6	3 NT	S 8	50	-3,0	3,0
3	20	16	3 NT	N 8	50	-3,0	3,0
7	12	24	3 NT	S 8	50	-3,0	3,0
19	36	43	3 NT	S 8	50	-3,0	3,0
10	9	27	4 Spar	N 9	50	-3,0	3,0
17	2	34	4 Spar	N 9	50	-3,0	3,0
9	26	10	2 NT	N 6	100	-16,0	16,0
21	38	41	2 NT	S 6	100	-16,0	16,0
16	3	33	3 NT	N 7	100	-16,0	16,0
2	17	19	3 NT	S 7	100	-16,0	16,0
20	37	42	3 NT	S 7	100	-16,0	16,0
1	44	18	4 Spar	N 8	100	-16,0	16,0

♠ Q53 Mappen: 2(34)
 ♥ AKT43 Rundenr: 17
 ♦ T72 NS (Ø)
 ♣ 84

♠ K972 T4
 ♥ J2 Q9865
 ♦ 64 AKQJ8
 ♣ KQ652 3

♠ AJ86
 ♥ 7
 ♦ 953
 ♣ AJT97

♠ K7654 Mappen: 4(36)
 ♥ 9853 Rundenr: 18
 ♦ 84 A (V)
 ♣ KT83

♠ 84 KQJT9765
 ♥ AQ9 JT32
 ♦ A62 4
 ♣ Q9762

♠ A32
 ♥ 8
 ♦ KQJT7
 ♣ AJ54

Bord	NS	ØV		NS	ØV	NS	ØV
19	35	42	4 Hjerter	D Ø 7	500	21,0	-21,0
14	4	30	4 Hjerter	D Ø 8	300	18,0	-18,0
5	13	21	4 Hjerter	D Ø 8	300	18,0	-18,0
10	8	26	3 NT	V 6	150	15,0	-15,0
6	22	12	2 Hjerter	Ø 6	100	11,0	-11,0
22	39	38	3 NT	V 7	100	11,0	-11,0
15	3	31	3 NT	V 7	100	11,0	-11,0
1	44	17	2 Hjerter	Ø 7	50	2,0	-2,0
12	6	28	2 Hjerter	Ø 7	50	2,0	-2,0
11	7	27	2 Hjerter	Ø 7	50	2,0	-2,0
9	25	9	3 Hjerter	Ø 8	50	2,0	-2,0
21	37	40	3 NT	V 8	50	2,0	-2,0
20	36	41	3 NT	V 8	50	2,0	-2,0
7	11	23	2 Hjerter	Ø 8	110	-9,0	9,0
17	1	33	2 Hjerter	Ø 8	110	-9,0	9,0
4	20	14	2 Hjerter	Ø 8	110	-9,0	9,0
3	19	15	2 Hjerter	Ø 8	110	-9,0	9,0
18	43	34	2 Hjerter	Ø 8	110	-9,0	9,0
13	29	5	3 Hjerter	Ø 9	140	-15,0	15,0
2	16	18	2 NT	N 6	200	-17,0	17,0
8	24	10	2 NT	N 5	300	-19,0	19,0
16	2	32	3 Ruter	D Ø 9	470	-21,0	21,0

Bord	NS	ØV		NS	ØV	NS	ØV
16	3	33	5 Ruter	D S 12	950	21,0	-21,0
12	7	29	5 Ruter	S 11	600	19,0	-19,0
5	14	22	6 Spar	D Ø 11	200	17,0	-17,0
7	12	24	4 Ruter	S 10	130	15,0	-15,0
21	38	41	4 Spar	Ø 10	620	12,0	-12,0
9	26	10	4 Spar	Ø 10	620	12,0	-12,0
15	4	32	4 Spar	Ø 11	650	-3,0	3,0
11	8	28	4 Spar	Ø 11	650	-3,0	3,0
19	36	43	4 Spar	Ø 11	650	-3,0	3,0
14	5	31	4 Spar	Ø 11	650	-3,0	3,0
2	17	19	4 Spar	Ø 11	650	-3,0	3,0
22	40	39	4 Spar	Ø 11	650	-3,0	3,0
13	30	6	4 Spar	Ø 11	650	-3,0	3,0
10	9	27	4 Spar	Ø 11	650	-3,0	3,0
8	25	11	4 Spar	Ø 11	650	-3,0	3,0
18	1	35	4 Spar	Ø 11	650	-3,0	3,0
1	44	18	5 Spar	Ø 11	650	-3,0	3,0
17	2	34	5 Spar	Ø 11	650	-3,0	3,0
4	21	15	5 Spar	Ø 11	650	-3,0	3,0
3	20	16	5 Spar	D Ø 11	850	-18,0	18,0
20	37	42	5 Spar	D Ø 11	850	-18,0	18,0
6	23	13	4 Spar	D Ø 11	990	-21,0	21,0

SPILLSTENSILER NM Damer, 03. august 2010

♠ K874 Mappnr: 5(37)
 ♥ KQ532 Rundenr: 19
 ♦ KQ NS (N)
 ♣ KQ

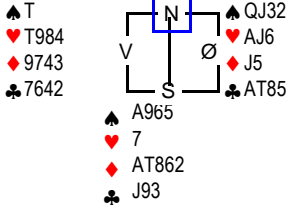

Bord	NS	ØV		NS	ØV	NS	ØV
15	5	33	4 Spar	D S 10	790	21,0	-21,0
8	26	12	3 NT	N 11	660	19,0	-19,0
9	27	11	3 NT	S 10	630	15,0	-15,0
12	8	30	3 NT	N 10	630	15,0	-15,0
22	41	40	3 NT	N 10	630	15,0	-15,0
4	22	16	4 Spar	S 10	620	7,0	-7,0
19	37	1	4 Spar	S 10	620	7,0	-7,0
14	6	32	4 Spar	S 10	620	7,0	-7,0
5	15	23	4 Spar	S 10	620	7,0	-7,0
18	2	36	4 Spar	S 10	620	7,0	-7,0
3	21	17	3 NT	S 9	600	0,0	0,0
16	4	34	3 NT	N 9	600	0,0	0,0
17	3	35	2 Kløver	D V 5	500	-3,0	3,0
21	39	42	1 NT	N 10	180	-6,0	6,0
6	24	14	2 NT	S 10	180	-6,0	6,0
13	31	7	2 Spar	S 10	170	-9,0	9,0
10	10	28	3 Kløver	V 7	100	-11,0	11,0
1	44	19	4 Spar	S 9	100	-15,0	15,0
2	18	20	4 Spar	S 9	100	-15,0	15,0
11	9	29	4 Spar	S 9	100	-15,0	15,0
7	13	25	4 Spar	S 8	200	-19,0	19,0
20	38	43	3 NT	N 6	300	-21,0	21,0

♠ Q5 Mappnr: 7(39)
 ♥ T732 Rundenr: 20
 ♦ A865 A (S)
 ♣ Q93

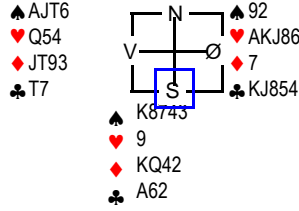

Bord	NS	ØV		NS	ØV	NS	ØV
14	7	33	3 Hjerter	Ø 7	200	21,0	-21,0
17	4	36	2 Spar	S 7	100	16,0	-16,0
18	3	37	2 Spar	S 7	100	16,0	-16,0
16	5	35	2 Spar	S 7	100	16,0	-16,0
3	22	18	2 Spar	S 7	100	16,0	-16,0
20	39	1	2 Hjerter	Ø 8	110	9,0	-9,0
19	38	2	2 Hjerter	Ø 8	110	9,0	-9,0
10	11	29	2 Hjerter	Ø 8	110	9,0	-9,0
2	19	21	2 Hjerter	Ø 9	140	2,0	-2,0
8	27	13	2 Hjerter	Ø 9	140	2,0	-2,0
11	10	30	2 Hjerter	Ø 9	140	2,0	-2,0
15	6	34	2 Hjerter	Ø 9	140	2,0	-2,0
6	25	15	2 Hjerter	Ø 10	170	-10,0	10,0
4	23	17	2 Hjerter	Ø 10	170	-10,0	10,0
21	40	43	2 Hjerter	Ø 10	170	-10,0	10,0
9	28	12	2 Hjerter	Ø 10	170	-10,0	10,0
13	32	8	2 Hjerter	Ø 10	170	-10,0	10,0
12	9	31	2 Hjerter	Ø 10	170	-10,0	10,0
1	44	20	3 Hjerter	Ø 10	170	-10,0	10,0
5	16	24	3 Hjerter	V 10	170	-10,0	10,0
22	42	41	4 Hjerter	Ø 10	620	-19,0	19,0
7	14	26	3 Spar	D Ø 9	730	-21,0	21,0

♠ K976 Mappnr: 6(38)
 ♥ AQ4 Rundenr: 19
 ♦ KQ985 ØV (Ø)
 ♣ 9

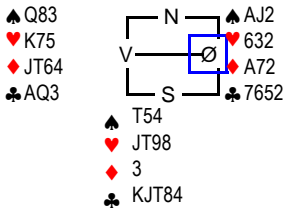

Bord	NS	ØV		NS	ØV	NS	ØV
15	5	33	2 Kløver	D V 6	500	21,0	-21,0
6	24	14	2 Hjerter	S 9	140	18,0	-18,0
21	39	42	2 Spar	N 9	140	18,0	-18,0
10	10	28	1 NT	N 8	120	15,0	-15,0
7	13	25	2 Hjerter	S 8	110	12,0	-12,0
18	2	36	2 Spar	N 8	110	12,0	-12,0
4	22	16	1 NT	Ø 6	100	6,0	-6,0
5	15	23	1 NT	Ø 6	100	6,0	-6,0
17	3	35	1 NT	Ø 6	100	6,0	-6,0
11	9	29	1 NT	Ø 6	100	6,0	-6,0
22	41	40	1 NT	S 7	90	0,0	0,0
1	44	19	2 Kløver	S 8	90	0,0	0,0
3	21	17	1 Hjerter	S 6	50	-9,0	9,0
14	6	32	2 Hjerter	S 7	50	-9,0	9,0
16	4	34	2 Hjerter	S 7	50	-9,0	9,0
8	26	12	2 NT	N 7	50	-9,0	9,0
12	8	30	2 Ruter	N 7	50	-9,0	9,0
20	38	43	2 Spar	N 7	50	-9,0	9,0
13	31	7	2 Spar	N 7	50	-9,0	9,0
19	37	1	1 NT	Ø 7	90	-18,0	18,0
2	18	20	1 NT	Ø 7	90	-18,0	18,0
9	27	11	2 Hjerter	S 6	100	-21,0	21,0

♠ AQ543 Mappnr: 8(40)
 ♥ K8 Rundenr: 20
 ♦ A6 I (V)
 ♣ KQJ7

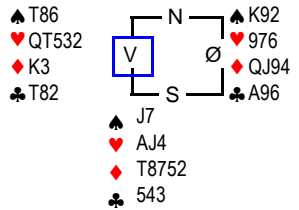

Bord	NS	ØV		NS	ØV	NS	ØV
3	22	18	3 NT	S 11	460	11,0	-11,0
1	44	20	3 NT	S 11	460	11,0	-11,0
10	11	29	3 NT	S 11	460	11,0	-11,0
9	28	12	3 NT	S 11	460	11,0	-11,0
6	25	15	3 NT	S 11	460	11,0	-11,0
7	14	26	3 NT	S 11	460	11,0	-11,0
16	5	35	3 NT	S 11	460	11,0	-11,0
8	27	13	3 NT	S 11	460	11,0	-11,0
2	19	21	3 NT	S 11	460	11,0	-11,0
20	39	1	3 NT	S 11	460	11,0	-11,0
5	16	24	3 NT	S 11	460	11,0	-11,0
21	40	43	3 NT	N 10	430	-4,0	4,0
13	32	8	3 NT	S 10	430	-4,0	4,0
22	42	41	3 NT	S 10	430	-4,0	4,0
12	9	31	3 NT	N 10	430	-4,0	4,0
17	4	36	4 Spar	N 10	420	-9,0	9,0
11	10	30	3 NT	S 9	400	-11,0	11,0
18	3	37	2 NT	S 10	180	-13,0	13,0
4	23	17	1 Spar	N 10	170	-17,0	17,0
15	6	34	1 Spar	N 10	170	-17,0	17,0
14	7	33	1 Spar	N 10	170	-17,0	17,0
19	38	2	3 Spar	N 9	140	-21,0	21,0

SPILLSTENSILER NM Damer, 03. august 2010

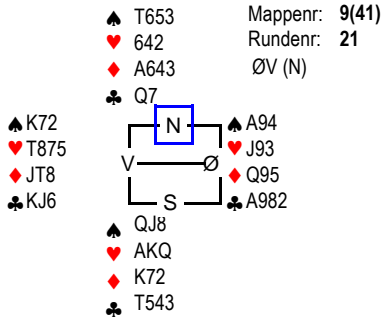

Bord	NS	ØV		NS	ØV	NS	ØV
21	41	1	1NT	S 8	120	21,0	-21,0
1	44	21	1NT	S 7	90	4,0	-4,0
5	17	25	1NT	S 7	90	4,0	-4,0
6	26	16	1NT	S 7	90	4,0	-4,0
7	15	27	1NT	S 7	90	4,0	-4,0
3	23	19	1NT	S 7	90	4,0	-4,0
20	40	2	1NT	N 7	90	4,0	-4,0
19	39	3	1NT	S 7	90	4,0	-4,0
13	33	9	1NT	S 7	90	4,0	-4,0
22	43	42	1NT	S 7	90	4,0	-4,0
15	7	35	1NT	S 7	90	4,0	-4,0
14	8	34	1NT	S 7	90	4,0	-4,0
10	12	30	1NT	N 7	90	4,0	-4,0
17	5	37	1NT	S 7	90	4,0	-4,0
11	11	31	1NT	S 7	90	4,0	-4,0
2	20	22	1NT	S 7	90	4,0	-4,0
8	28	14	1NT	S 7	90	4,0	-4,0
4	24	18	1NT	S 6	50	-14,0	14,0
16	6	36	1NT	S 6	50	-14,0	14,0
12	10	32	1NT	S 5	100	-19,0	19,0
18	4	38	1NT	S 5	100	-19,0	19,0
9	29	13	2NT	S 6	100	-19,0	19,0

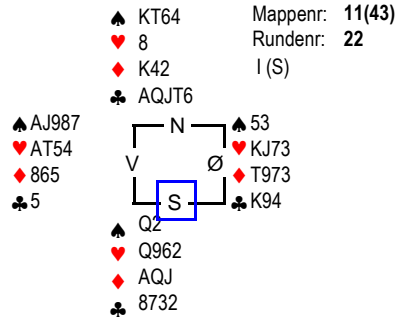

Bord	NS	ØV		NS	ØV	NS	ØV
15	8	36	3NT	N 9	400	21,0	-21,0
9	30	14	1NT	N 9	150	13,0	-13,0
5	18	26	1NT	N 9	150	13,0	-13,0
3	24	20	1NT	N 9	150	13,0	-13,0
13	34	10	1NT	N 9	150	13,0	-13,0
2	21	23	2NT	N 9	150	13,0	-13,0
10	13	31	2NT	N 9	150	13,0	-13,0
21	42	2	2NT	N 9	150	13,0	-13,0
12	11	33	2 Kløver	S 10	130	4,0	-4,0
6	27	17	2 Kløver	N 10	130	4,0	-4,0
4	25	19	2NT	S 8	120	1,0	-1,0
17	6	38	2 Kløver	N 9	110	-2,0	2,0
8	29	15	2 Kløver	N 9	110	-2,0	2,0
16	7	37	2 Spar	V 6	100	-5,0	5,0
20	41	3	3NT	N 8	50	-12,0	12,0
19	40	4	3NT	N 8	50	-12,0	12,0
11	12	32	3NT	N 8	50	-12,0	12,0
22	1	43	3NT	N 8	50	-12,0	12,0
7	16	28	3NT	N 8	50	-12,0	12,0
18	5	39	3NT	N 8	50	-12,0	12,0
1	44	22	3NT	S 7	100	-20,0	20,0
14	9	35	5 Kløver	N 9	100	-20,0	20,0

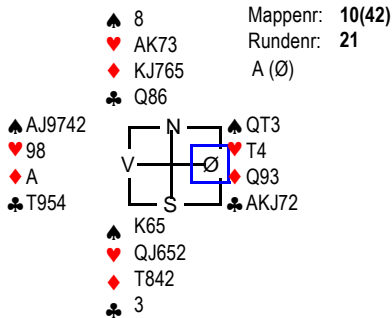

Bord	NS	ØV		NS	ØV	NS	ØV
13	33	9	4 Hjerter	S 10	620	21,0	-21,0
2	20	22	3 Hjerter	S 9	140	19,0	-19,0
17	5	37	4 Spar	V 9	100	17,0	-17,0
7	15	27	4 Hjerter	S 9	100	14,0	-14,0
21	41	1	4 Hjerter	S 9	100	14,0	-14,0
18	4	38	4 Kløver	Ø 10	130	11,0	-11,0
19	39	3	2 Spar	V 10	170	4,0	-4,0
15	7	35	2 Spar	V 10	170	4,0	-4,0
11	11	31	3 Spar	V 10	170	4,0	-4,0
4	24	18	3 Spar	V 10	170	4,0	-4,0
1	44	21	3 Spar	V 10	170	4,0	-4,0
3	23	19	3 Spar	V 10	170	4,0	-4,0
16	6	36	3 Spar	V 11	200	-3,0	3,0
5	17	25	4 Spar	V 10	620	-11,0	11,0
22	43	42	4 Spar	V 10	620	-11,0	11,0
6	26	16	4 Spar	V 10	620	-11,0	11,0
14	8	34	4 Spar	V 10	620	-11,0	11,0
10	12	30	4 Spar	V 10	620	-11,0	11,0
9	29	13	4 Spar	V 10	620	-11,0	11,0
8	28	14	4 Spar	V 10	620	-11,0	11,0
20	40	2	4 Spar	Ø 11	650	-19,0	19,0
12	10	32	4 Spar	V 12	680	-21,0	21,0

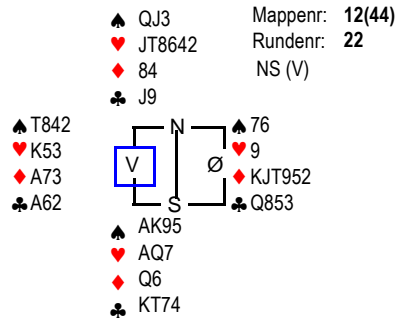

Bord	NS	ØV		NS	ØV	NS	ØV
15	8	36	5 Ruter	D V 7	800	21,0	-21,0
14	9	35	4 Hjerter	N 10	620	18,0	-18,0
1	44	22	4 Hjerter	N 10	620	18,0	-18,0
4	25	19	5 Ruter	D Ø 8	500	15,0	-15,0
20	41	3	5 Ruter	D Ø 9	300	11,0	-11,0
22	1	43	5 Ruter	D V 9	300	11,0	-11,0
8	29	15	5 Ruter	D Ø 9	300	11,0	-11,0
7	16	28	3 Hjerter	S 9	140	4,0	-4,0
3	24	20	3 Hjerter	N 9	140	4,0	-4,0
10	13	31	3 Hjerter	N 9	140	4,0	-4,0
11	12	32	3 Hjerter	N 9	140	4,0	-4,0
19	40	4	4 Ruter	Ø 9	50	-2,0	2,0
13	34	10	4 Ruter	Ø 9	50	-2,0	2,0
5	18	26	4 Hjerter	N 9	100	-11,0	11,0
17	6	38	4 Hjerter	N 9	100	-11,0	11,0
16	7	37	4 Hjerter	N 9	100	-11,0	11,0
12	11	33	4 Hjerter	N 9	100	-11,0	11,0
2	21	23	4 Hjerter	N 9	100	-11,0	11,0
18	5	39	4 Hjerter	N 9	100	-11,0	11,0
6	27	17	4 Hjerter	N 9	100	-11,0	11,0
21	42	2	5 Hjerter	N 9	200	-19,0	19,0
9	30	14	4 Ruter	D Ø 10	510	-21,0	21,0

SPILLSTENSILER NM Damer, 03. august 2010

♠ 86 Mappen: 13(45)
 ♥ K9864 Rundenr: 23
 ♦ A J 63 A (N)
 ♣ 98

♠ A2
♥ 3
♦ K9752
♣ AKQ62

♠ 9753
♥ AJ72
♦ T4
♣ JT7

♠ KQJT4
♥ QT5
♦ Q8
♣ 543

Bord	NS	ØV		NS	ØV	NS	ØV
17	7	39	5 Ruter	V 7	400	21,0	-21,0
1	44	23	3 Ruter	V 6	300	18,0	-18,0
18	6	40	5 Ruter	V 8	300	18,0	-18,0
16	8	38	3 Kløver	V 7	200	13,0	-13,0
2	22	24	4 Kløver	Ø 8	200	13,0	-13,0
10	14	32	6 Kløver	V 10	200	13,0	-13,0
7	17	29	2 Hjerter	N 8	110	9,0	-9,0
13	35	11	2 Ruter	Ø 7	100	1,0	-1,0
6	28	18	2 Ruter	V 7	100	1,0	-1,0
8	30	16	3 Kløver	V 8	100	1,0	-1,0
22	2	1	3 Kløver	Ø 8	100	1,0	-1,0
14	10	36	3 Kløver	V 8	100	1,0	-1,0
15	9	37	4 Kløver	Ø 9	100	1,0	-1,0
4	26	20	4 Kløver	Ø 9	100	1,0	-1,0
19	41	5	3 Hjerter	N 8	100	-8,0	8,0
9	31	15	3 Hjerter	N 8	100	-8,0	8,0
12	12	34	3 Kløver	V 9	110	-13,0	13,0
21	43	3	3 Kløver	Ø 9	110	-13,0	13,0
11	13	33	3 Kløver	V 9	110	-13,0	13,0
5	19	27	3 Kløver	V 10	130	-19,0	19,0
20	42	4	3 Kløver	V 10	130	-19,0	19,0
3	25	21	4 Kløver	V 10	130	-19,0	19,0

♠ AQJ76532 Mappen: 15(47)
 ♥ AQ7 Rundenr: 24
 ♦ AK NS (S)

♠ KJT76
♥ K
♦ 95
♣ Q9765

♠ AQ853
♥ 4
♦ JT632
♣ T8

♠ 942
♥ T98
♦ K84
♣ J432

Bord	NS	ØV		NS	ØV	NS	ØV
20	43	5	7 Hjerter	N 13	2210	21,0	-21,0
14	11	37	6 Hjerter	N 13	1460	11,0	-11,0
17	8	40	6 Hjerter	N 13	1460	11,0	-11,0
19	42	6	6 Hjerter	N 13	1460	11,0	-11,0
2	23	25	6 Hjerter	N 13	1460	11,0	-11,0
15	10	38	6 Hjerter	N 13	1460	11,0	-11,0
11	14	34	6 Hjerter	N 13	1460	11,0	-11,0
13	36	12	6 Hjerter	N 13	1460	11,0	-11,0
12	13	35	6 Hjerter	S 13	1460	11,0	-11,0
8	31	17	6 Hjerter	N 13	1460	11,0	-11,0
3	26	22	6 Spar	D V 8	800	-1,0	1,0
18	7	41	6 Spar	D V 8	800	-1,0	1,0
10	15	33	6 Spar	D V 8	800	-1,0	1,0
7	18	30	4 Hjerter	N 13	710	-9,0	9,0
6	29	19	5 Hjerter	N 13	710	-9,0	9,0
1	44	24	5 Hjerter	N 13	710	-9,0	9,0
9	32	16	5 Hjerter	N 13	710	-9,0	9,0
5	20	28	5 Hjerter	N 13	710	-9,0	9,0
21	1	4	5 Spar	D V 8	500	-15,0	15,0
4	27	21	5 Spar	D V 9	300	-18,0	18,0
16	9	39	5 Spar	D V 9	300	-18,0	18,0
22	3	2	4 Spar	D Ø 9	100	-21,0	21,0

♠ JT93 Mappen: 14(46)
 ♥ 83 Rundenr: 23
 ♦ QT874 I (Ø)
 ♣ A4

♠ 8
♥ Q9652
♦ 52
♣ KQ965

♠ AQ
♥ KT74
♦ K963
♣ J83

♠ K76542
♥ AJ
♦ AJ
♣ T72

Bord	NS	ØV		NS	ØV	NS	ØV
12	12	34	4 Spar	D S 11	690	19,9	-19,9
1	44	23	4 Spar	D S 11	690	19,9	-19,9
21	43	3	4 Spar	S 11	450	16,8	-16,8
19	41	5	4 Spar	S 10	420	13,6	-13,6
11	13	33	4 Spar	S 10	420	13,6	-13,6
9	31	15	3 Spar	S 12	230	10,5	-10,5
6	28	18	2 Spar	S 11	200	8,4	-8,4
8	30	16	3 Spar	S 10	170	3,1	-3,1
10	14	32	3 Spar	S 10	170	3,1	-3,1
15	9	37	3 Spar	S 10	170	3,1	-3,1
20	42	4	3 Spar	S 10	170	3,1	-3,1
4	26	20	2 Spar	S 9	140	-2,1	2,1
2	22	24	40%-40%			-4,2	-4,2
3	25	21	4 Hjerter	Ø 8	100	-6,3	6,3
13	35	11	5 Hjerter	D Ø 10	100	-6,3	6,3
18	6	40	5 Hjerter	V 9	100	-6,3	6,3
16	8	38	4 Hjerter	Ø 9	50	-12,6	12,6
22	2	1	4 Hjerter	Ø 9	50	-12,6	12,6
7	17	29	4 Hjerter	Ø 9	50	-12,6	12,6
17	7	39	5 Spar	S 10	50	-16,8	16,8
14	10	36	4 Hjerter	Ø 10	420	-19,9	19,9
5	19	27	4 Hjerter	Ø 10	420	-19,9	19,9

♠ A9654 Mappen: 16(48)
 ♥ AKT Rundenr: 24
 ♦ J7 ØV (V)
 ♣ 962

♠ KJT87
♥ Q2
♦ Q4
♣ K853

♠ 32
♥ 95
♦ K9863
♣ AQ74

♠ Q
♥ J87643
♦ AT52
♣ JT

Bord	NS	ØV		NS	ØV	NS	ØV
21	1	4	3 Hjerter	D S 10	630	21,0	-21,0
6	29	19	1 NT	Ø 5	200	16,0	-16,0
15	10	38	1 NT	Ø 5	200	16,0	-16,0
7	18	30	1 NT	Ø 5	200	16,0	-16,0
12	13	35	3 Hjerter	N 11	200	16,0	-16,0
9	32	16	1 NT	S 10	180	10,0	-10,0
8	31	17	1 NT	S 10	180	10,0	-10,0
22	3	2	2 Hjerter	S 10	170	5,0	-5,0
11	14	34	3 Hjerter	S 10	170	5,0	-5,0
5	20	28	3 Hjerter	S 10	170	5,0	-5,0
20	43	5	1 NT	S 9	150	1,0	-1,0
13	36	12	2 Hjerter	S 9	140	-2,0	2,0
3	26	22	3 Hjerter	S 9	140	-2,0	2,0
2	23	25	1 NT	S 8	120	-6,0	6,0
1	44	24	1 NT	S 8	120	-6,0	6,0
17	8	40	2 NT	V 7	100	-12,0	12,0
14	11	37	2 Spar	V 7	100	-12,0	12,0
10	15	33	2 Spar	V 7	100	-12,0	12,0
18	7	41	3 Kløver	V 8	100	-12,0	12,0
19	42	6	2 Spar	V 8	110	-18,0	18,0
16	9	39	2 Spar	V 8	110	-18,0	18,0
4	27	21	2 Spar	D V 8	670	-21,0	21,0

SPILLSTENSILER NM Damer, 03. august 2010

♠ T94 Mappen: 17(49)
♥ AQ Rundenr: 25
♦ KJ87 I (N)
♣ QJT2

♠ K72
♥ T93
♦ QT432
♣ 76

♠ AQJ8653
♥ K764
♦ A
♣ 8

♠ J852
♥ 965
♣ AK9543

♠ J65 Mappen: 19(51)
♥ J96 Rundenr: 26
♦ KQ53 ØV (S)
♣ K42

♠ A873
♥ Q3
♦ JT
♣ Q9863

♠ KQT
♥ A87
♦ 9742
♣ JT7

♠ 942
♥ KT542
♦ A86
♣ A5

Bord	NS	ØV		NS	ØV	NS	ØV
18	8	42	5 Kløver	D N 12	650	21,0	-21,0
10	16	34	5 Kløver	N 11	400	18,0	-18,0
1	44	25	5 Kløver	N 11	400	18,0	-18,0
22	4	3	5 Spar	D Ø 9	300	15,0	-15,0
14	12	38	5 Spar	Ø 9	100	10,0	-10,0
15	11	39	5 Spar	Ø 9	100	10,0	-10,0
2	24	26	5 Spar	Ø 9	100	10,0	-10,0
19	43	7	5 Spar	Ø 9	100	10,0	-10,0
16	10	40	4 Spar	Ø 9	50	-2,0	2,0
7	19	31	4 Spar	Ø 9	50	-2,0	2,0
11	15	35	4 Spar	Ø 9	50	-2,0	2,0
9	33	17	4 Spar	V 9	50	-2,0	2,0
13	37	13	4 Spar	Ø 9	50	-2,0	2,0
3	27	23	5 Spar	Ø 10	50	-2,0	2,0
8	32	18	5 Spar	Ø 10	50	-2,0	2,0
21	2	5	5 Spar	Ø 10	50	-2,0	2,0
6	30	20	3 Spar	Ø 9	140	-11,0	11,0
5	21	29	3 Spar	Ø 10	170	-15,0	15,0
20	1	6	3 Spar	Ø 10	170	-15,0	15,0
17	9	41	3 Spar	Ø 10	170	-15,0	15,0
4	28	22	6 Kløver	D N 10	300	-19,0	19,0
12	14	36	4 Spar	Ø 10	420	-21,0	21,0

Bord	NS	ØV		NS	ØV	NS	ØV
20	2	7	2 Hjerter	S 8	110	18,0	-18,0
7	20	32	2 Hjerter	S 8	110	18,0	-18,0
12	15	37	2 Hjerter	S 8	110	18,0	-18,0
11	16	36	2 Hjerter	S 8	110	18,0	-18,0
18	9	43	1 NT	N 7	90	12,0	-12,0
22	5	4	1 NT	N 7	90	12,0	-12,0
21	3	6	Pass			0,0	0,0
8	33	19	Pass			0,0	0,0
10	17	35	Pass			0,0	0,0
17	10	42	Pass			0,0	0,0
2	25	27	Pass			0,0	0,0
1	44	26	Pass			0,0	0,0
15	12	40	Pass			0,0	0,0
14	13	39	Pass			0,0	0,0
4	29	23	Pass			0,0	0,0
5	22	30	Pass			0,0	0,0
16	11	41	3 Hjerter	S 8	50	-16,0	16,0
3	28	24	3 Hjerter	S 8	50	-16,0	16,0
9	34	18	3 Hjerter	S 8	50	-16,0	16,0
13	38	14	3 Hjerter	S 8	50	-16,0	16,0
6	31	21	3 Hjerter	S 8	50	-16,0	16,0
19	1	8	3 Hjerter	S 8	50	-16,0	16,0

♠ A832 Mappen: 18(50)
♥ 983 Rundenr: 25
♦ K5 NS (Ø)
♣ Q972

♠ 54
♥ K65
♦ QJ9874
♣ A8

♠ T76
♥ AQT42
♦ 63
♣ K54

♠ KQJ9
♥ J7
♦ AT2
♣ JT63

♠ QJ3 Mappen: 20(52)
♥ J42 Rundenr: 26
♦ 985 A (V)
♣ J843

♠ T9
♥ T63
♦ AJ76432
♣ 2

♠ K2
♥ AK75
♦ QT
♣ AKQT5

♠ A87654
♥ Q98
♦ K
♣ 976

Bord	NS	ØV		NS	ØV	NS	ØV
22	4	3	3 Spar	D S 9	730	21,0	-21,0
14	12	38	1 Spar	S 9	140	4,0	-4,0
12	14	36	2 Spar	S 9	140	4,0	-4,0
1	44	25	2 Spar	S 9	140	4,0	-4,0
4	28	22	2 Spar	N 9	140	4,0	-4,0
11	15	35	2 Spar	N 9	140	4,0	-4,0
18	8	42	2 Spar	S 9	140	4,0	-4,0
19	43	7	2 Spar	N 9	140	4,0	-4,0
8	32	18	2 Spar	N 9	140	4,0	-4,0
21	2	5	2 Spar	S 9	140	4,0	-4,0
13	37	13	2 Spar	N 9	140	4,0	-4,0
3	27	23	2 Spar	S 9	140	4,0	-4,0
9	33	17	3 Spar	N 9	140	4,0	-4,0
7	19	31	3 Spar	N 9	140	4,0	-4,0
5	21	29	3 Spar	N 9	140	4,0	-4,0
6	30	20	3 Spar	N 9	140	4,0	-4,0
10	16	34	3 Spar	S 9	140	4,0	-4,0
20	1	6	2 Spar	N 8	110	-14,0	14,0
15	11	39	3 Kløver	S 9	110	-14,0	14,0
16	10	40	3 Hjerter	Ø 8	50	-17,0	17,0
17	9	41	3 Ruter	V 9	110	-20,0	20,0
2	24	26	3 Ruter	V 9	110	-20,0	20,0

Bord	NS	ØV		NS	ØV	NS	ØV
17	10	42	6 NT	Ø 7	500	21,0	-21,0
16	11	41	6 NT	Ø 8	400	18,0	-18,0
15	12	40	6 NT	Ø 8	400	18,0	-18,0
2	25	27	3 NT	Ø 7	200	15,0	-15,0
10	17	35	3 NT	Ø 8	100	2,0	-2,0
1	44	26	3 NT	Ø 8	100	2,0	-2,0
6	31	21	3 NT	Ø 8	100	2,0	-2,0
3	28	24	3 NT	Ø 8	100	2,0	-2,0
4	29	23	3 NT	Ø 8	100	2,0	-2,0
8	33	19	3 NT	V 8	100	2,0	-2,0
14	13	39	3 NT	Ø 8	100	2,0	-2,0
19	1	8	3 NT	Ø 8	100	2,0	-2,0
9	34	18	3 NT	Ø 8	100	2,0	-2,0
12	15	37	3 NT	Ø 8	100	2,0	-2,0
5	22	30	6 Ruter	V 11	100	2,0	-2,0
21	3	6	6 Ruter	V 11	100	2,0	-2,0
20	2	7	3 NT	Ø 9	600	-12,0	12,0
18	9	43	5 Ruter	V 11	600	-12,0	12,0
7	20	32	3 NT	Ø 10	630	-16,0	16,0
13	38	14	3 NT	Ø 10	630	-16,0	16,0
11	16	36	6 Ruter	V 12	1370	-20,0	20,0
22	5	4	6 Ruter	Ø 12	1370	-20,0	20,0

SPILLSTENSILER NM Damer, 03. august 2010

♠ AT62 Mappen: 21(53)
 ♥ K Rundenr: 27
 ♦ Q976 NS (N)
 ♣ J543

♠ KQ9874
 ♥ A4
 ♦ KJ5
 ♣ Q9

♠ JT98652
 ♥ T42
 ♦ A82

♠ A87 Mappen: 23(55)
 ♥ K98 Rundenr: 28
 ♦ KJT5 A (S)
 ♣ T64

♠ QJ32
 ♥ 764
 ♦ 842
 ♣ KQ3

♠ K954
 ♥ AQJT3
 ♦ Q7
 ♣ J2

♠ T6
 ♥ 52
 ♦ A963
 ♣ A9875

Bord	NS	ØV	NS	ØV	NS	ØV
12	16	38	2 Spar	Ø 9	140	21,0 -21,0
13	39	15	2 Spar	Ø 10	170	18,0 -18,0
21	4	7	2 Spar	Ø 10	170	18,0 -18,0
2	26	28	2 Spar	Ø 11	200	15,0 -15,0
14	14	40	4 Hjerter	Ø 10	420	-2,0 2,0
20	3	8	4 Spar	Ø 10	420	-2,0 2,0
11	17	37	4 Spar	Ø 10	420	-2,0 2,0
15	13	41	4 Spar	Ø 10	420	-2,0 2,0
16	12	42	4 Spar	Ø 10	420	-2,0 2,0
18	10	1	4 Spar	Ø 10	420	-2,0 2,0
3	29	25	4 Spar	Ø 10	420	-2,0 2,0
10	18	36	4 Spar	Ø 10	420	-2,0 2,0
4	30	24	4 Spar	Ø 10	420	-2,0 2,0
19	2	9	4 Spar	Ø 10	420	-2,0 2,0
17	11	43	4 Spar	Ø 10	420	-2,0 2,0
1	44	27	4 Spar	Ø 10	420	-2,0 2,0
6	32	22	4 Spar	Ø 10	420	-2,0 2,0
7	21	33	4 Spar	Ø 10	420	-2,0 2,0
8	34	20	4 Spar	Ø 10	420	-2,0 2,0
9	35	19	4 Spar	Ø 10	420	-2,0 2,0
5	23	31	4 Spar	Ø 11	450	-19,0 19,0
22	6	5	3 NNT	V 12	490	-21,0 21,0

Bord	NS	ØV	NS	ØV	NS	ØV
2	27	29	4 Spar	V 8	200	21,0 -21,0
6	33	23	3 Ruter	N 9	110	19,0 -19,0
20	4	9	3 Hjerter	Ø 8	100	17,0 -17,0
12	17	39	3 Kløver	S 8	100	13,0 -13,0
21	5	8	3 Ruter	N 8	100	13,0 -13,0
1	44	28	3 Ruter	N 8	100	13,0 -13,0
17	12	1	2 Hjerter	Ø 8	110	3,0 -3,0
19	3	10	2 Hjerter	Ø 8	110	3,0 -3,0
7	22	34	2 Hjerter	Ø 8	110	3,0 -3,0
8	35	21	2 Hjerter	Ø 8	110	3,0 -3,0
16	13	43	2 Spar	V 8	110	3,0 -3,0
11	18	38	2 Spar	V 8	110	3,0 -3,0
13	40	16	2 Spar	Ø 8	110	3,0 -3,0
18	11	2	2 Hjerter	Ø 9	140	-9,0 9,0
3	30	26	2 Hjerter	Ø 9	140	-9,0 9,0
4	31	25	2 Hjerter	Ø 9	140	-9,0 9,0
22	7	6	2 Spar	V 9	140	-9,0 9,0
15	14	42	3 Hjerter	Ø 9	140	-9,0 9,0
5	24	32	2 Hjerter	Ø 10	170	-17,0 17,0
10	19	37	2 Hjerter	Ø 10	170	-17,0 17,0
14	15	41	2 Spar	V 10	170	-17,0 17,0
9	36	20	3 Ruter	N 7	200	-21,0 21,0

♠ A753 Mappen: 22(54)
 ♥ T72 Rundenr: 27
 ♦ KJ9 ØV (Ø)
 ♣ 652

♠ K92
 ♥ AJ4
 ♦ AQ42
 ♣ A74

♠ QJ8
 ♥ K3
 ♦ T765
 ♣ JT83

♠ T64
 ♥ Q9865
 ♦ 83
 ♣ KQ9

♠ K92 Mappen: 24(56)
 ♥ AQ72 Rundenr: 28
 ♦ 92 I (V)
 ♣ AK62

♠ 4
 ♥ KT6
 ♦ T75
 ♣ JT9873

♠ A8
 ♥ J9853
 ♦ J8643
 ♣ 5

♠ QJT7653
 ♥ 4
 ♦ AKQ
 ♣ Q4

Bord	NS	ØV	NS	ØV	NS	ØV
12	16	38	3 NNT	V 7	200	17,0 -17,0
11	17	37	3 NNT	Ø 7	200	17,0 -17,0
1	44	27	3 NNT	Ø 7	200	17,0 -17,0
3	29	25	3 NNT	Ø 7	200	17,0 -17,0
21	4	7	3 NNT	V 7	200	17,0 -17,0
13	39	15	3 NNT	Ø 8	100	3,0 -3,0
5	23	31	3 NNT	Ø 8	100	3,0 -3,0
18	10	1	3 NNT	Ø 8	100	3,0 -3,0
8	34	20	3 NNT	Ø 8	100	3,0 -3,0
9	35	19	3 NNT	Ø 8	100	3,0 -3,0
22	6	5	3 NNT	Ø 8	100	3,0 -3,0
2	26	28	3 NNT	Ø 8	100	3,0 -3,0
4	30	24	3 NNT	Ø 8	100	3,0 -3,0
14	14	40	3 NNT	Ø 8	100	3,0 -3,0
17	11	43	1 NNT	V 7	90	-8,0 8,0
10	18	36	1 NNT	V 7	90	-8,0 8,0
19	2	9	2 Hjerter	N 6	100	-11,0 11,0
16	12	42	1 NNT	V 8	120	-17,0 17,0
15	13	41	1 NNT	V 8	120	-17,0 17,0
7	21	33	2 NNT	V 8	120	-17,0 17,0
6	32	22	2 NNT	V 8	120	-17,0 17,0
20	3	8	2 NNT	V 8	120	-17,0 17,0

Bord	NS	ØV	NS	ØV	NS	ØV
8	35	21	6 Spar	N 12	980	9,0 -9,0
19	3	10	6 Spar	N 12	980	9,0 -9,0
3	30	26	6 Spar	N 12	980	9,0 -9,0
20	4	9	6 Spar	N 12	980	9,0 -9,0
1	44	28	6 Spar	N 12	980	9,0 -9,0
11	18	38	6 Spar	N 12	980	9,0 -9,0
10	19	37	6 Spar	S 12	980	9,0 -9,0
12	17	39	6 Spar	N 12	980	9,0 -9,0
16	13	43	6 Spar	N 12	980	9,0 -9,0
13	40	16	6 Spar	N 12	980	9,0 -9,0
22	7	6	6 Spar	N 12	980	9,0 -9,0
14	15	41	6 Spar	N 12	980	9,0 -9,0
17	12	1	6 Spar	N 12	980	9,0 -9,0
18	11	2	2 Hjerter	D Ø 5	500	-5,0 5,0
15	14	42	5 NNT	N 12	490	-7,0 7,0
2	27	29	4 Spar	N 12	480	-13,0 13,0
5	24	32	4 Spar	N 12	480	-13,0 13,0
6	33	23	4 Spar	N 12	480	-13,0 13,0
9	36	20	5 Spar	N 12	480	-13,0 13,0
7	22	34	5 Spar	N 12	480	-13,0 13,0
4	31	25	4 Hjerter	N 9	50	-19,0 19,0
21	5	8	4 Hjerter	S 8	100	-21,0 21,0

SPILLSTENSILER NM Damer, 03. august 2010

♠ AK875 Mappen: 25(57)
 ♥ AQ8 Rundenr: 29
 ♦ A ØV (N)
 ♣ AJ85

♠ Q963
 ♥ T6532
 ♦ QT5
 ♣ K

♠ JT4
 ♥ 97
 ♦ 82
 ♣ QT6432

♠ JT985 Mappen: 27(59)
 ♥ JT432 Rundenr: 30
 ♦ QT I (S)
 ♣ 7

♠ 4
 ♥ K
 ♦ 98642
 ♣ AKQ953

♠ AK632
 ♥ A96
 ♦ J75
 ♣ 84

♠ Q7
 ♥ Q875
 ♦ AK3
 ♣ JT62

Bord	NS	ØV		NS	ØV	NS	ØV
1	44	29	6 Kløver	N 13	940	20,0	-20,0
18	12	3	6 Kløver	N 13	940	20,0	-20,0
15	15	43	3 NT	N 13	520	17,0	-17,0
13	41	17	4 Spar	N 12	480	12,0	-12,0
19	4	11	4 Spar	N 12	480	12,0	-12,0
20	5	10	4 Spar	N 12	480	12,0	-12,0
10	20	38	4 Spar	N 12	480	12,0	-12,0
4	32	26	4 Spar	N 11	450	0,0	0,0
2	28	30	4 Spar	N 11	450	0,0	0,0
22	8	7	4 Spar	N 11	450	0,0	0,0
17	13	2	4 Spar	N 11	450	0,0	0,0
9	37	21	4 Spar	N 11	450	0,0	0,0
16	14	1	4 Spar	N 11	450	0,0	0,0
7	23	35	4 Spar	N 11	450	0,0	0,0
12	18	40	4 Spar	N 11	450	0,0	0,0
5	25	33	3 NT	N 10	430	-9,0	9,0
3	31	27	4 Spar	N 10	420	-14,0	14,0
11	19	39	4 Spar	N 10	420	-14,0	14,0
21	6	9	4 Spar	N 10	420	-14,0	14,0
14	16	42	5 Kløver	N 12	420	-14,0	14,0
8	36	22	3 Kløver	N 13	190	-19,0	19,0
6	34	24	3 Spar	N 10	170	-21,0	21,0

Bord	NS	ØV		NS	ØV	NS	ØV
11	20	40	4 Spar	Ø 6	200	21,0	-21,0
1	44	30	2 Hjerter	N 9	140	18,0	-18,0
6	35	25	2 Hjerter	N 9	140	18,0	-18,0
19	5	12	2 Hjerter	N 8	110	15,0	-15,0
15	16	1	3 NT	Ø 7	100	9,0	-9,0
14	17	43	3 NT	Ø 7	100	9,0	-9,0
16	15	2	3 NT	V 7	100	9,0	-9,0
2	29	31	5 Ruter	V 9	100	9,0	-9,0
12	19	41	5 Ruter	Ø 9	100	9,0	-9,0
9	38	22	2 Spar	Ø 7	50	2,0	-2,0
10	21	39	3 Spar	Ø 8	50	2,0	-2,0
22	9	8	3 Hjerter	N 8	50	-2,0	2,0
5	26	34	3 Spar	N 8	50	-2,0	2,0
4	33	27	2 Hjerter	D N 7	100	-7,0	7,0
3	32	28	3 Hjerter	N 7	100	-7,0	7,0
8	37	23	3 Hjerter	N 7	100	-7,0	7,0
7	24	36	2 Kløver	V 9	110	-13,0	13,0
21	7	10	3 Kløver	V 9	110	-13,0	13,0
18	13	4	3 Kløver	Ø 9	110	-13,0	13,0
13	42	18	3 Spar	D N 7	300	-17,0	17,0
20	6	11	3 NT	V 9	400	-19,0	19,0
17	14	3	3 NT	Ø 10	430	-21,0	21,0

♠ KT432 Mappen: 26(58)
 ♥ KQ7 Rundenr: 29
 ♦ 987 A (Ø)
 ♣ 94

♠ AQ9
 ♥ T86
 ♦ AQJ54
 ♣ 86

♠ J6
 ♥ J92
 ♦ T
 ♣ AKJT753

♠ QT2 Mappen: 28(60)
 ♥ AKT632 Rundenr: 30
 ♦ K32 NS (V)
 ♣ J

♠ A854
 ♥ Q94
 ♦ AQT
 ♣ 873

♠ 9
 ♥ 87
 ♦ J85
 ♣ AQT9652

♠ KJ763
 ♥ J5
 ♦ 9764
 ♣ K4

Bord	NS	ØV		NS	ØV	NS	ØV
2	28	30	2 Spar	N 11	200	20,0	-20,0
9	37	21	3 Ruter	V 7	200	20,0	-20,0
16	14	1	3 Kløver	S 10	130	4,0	-4,0
22	8	7	3 Kløver	S 10	130	4,0	-4,0
3	31	27	3 Kløver	S 10	130	4,0	-4,0
13	41	17	3 Kløver	S 10	130	4,0	-4,0
14	16	42	3 Kløver	S 10	130	4,0	-4,0
4	32	26	3 Kløver	S 10	130	4,0	-4,0
21	6	9	3 Kløver	S 10	130	4,0	-4,0
20	5	10	3 Kløver	S 10	130	4,0	-4,0
11	19	39	3 Kløver	S 10	130	4,0	-4,0
1	44	29	3 Kløver	S 10	130	4,0	-4,0
6	34	24	3 Kløver	N 10	130	4,0	-4,0
19	4	11	3 Kløver	S 10	130	4,0	-4,0
10	20	38	4 Kløver	S 10	130	4,0	-4,0
15	15	43	4 Kløver	S 10	130	4,0	-4,0
18	12	3	3 Ruter	V 8	100	-13,0	13,0
5	25	33	3 Ruter	V 8	100	-13,0	13,0
12	18	40	4 Ruter	V 9	100	-13,0	13,0
17	13	2	2 Ruter	V 8	90	-17,0	17,0
8	36	22	3 Ruter	V 9	110	-19,0	19,0
7	23	35	3 Spar	N 7	200	-21,0	21,0

Bord	NS	ØV		NS	ØV	NS	ØV
14	17	43	5 Kløver	D Ø 9	300	21,0	-21,0
13	42	18	5 Kløver	V 8	150	19,0	-19,0
1	44	30	3 Hjerter	N 9	140	16,0	-16,0
11	20	40	3 Spar	S 9	140	16,0	-16,0
18	13	4	3 NT	V 7	100	7,0	-7,0
17	14	3	5 Kløver	Ø 9	100	7,0	-7,0
22	9	8	5 Kløver	V 9	100	7,0	-7,0
10	21	39	5 Kløver	V 9	100	7,0	-7,0
12	19	41	5 Kløver	Ø 9	100	7,0	-7,0
2	29	31	5 Kløver	V 9	100	7,0	-7,0
6	35	25	5 Kløver	V 9	100	7,0	-7,0
19	5	12	4 Kløver	Ø 9	50	-3,0	3,0
21	7	10	4 Kløver	Ø 9	50	-3,0	3,0
20	6	11	4 Kløver	Ø 9	50	-3,0	3,0
8	37	23	3 Kløver	Ø 9	110	-11,0	11,0
16	15	2	3 Kløver	Ø 9	110	-11,0	11,0
15	16	1	3 Kløver	V 9	110	-11,0	11,0
3	32	28	3 Kløver	V 9	110	-11,0	11,0
7	24	36	3 Kløver	V 9	110	-11,0	11,0
4	33	27	3 Hjerter	N 7	200	-17,0	17,0
9	38	22	4 Hjerter	N 7	300	-19,0	19,0
5	26	34	4 Hjerter	N 6	400	-21,0	21,0

SPILLSTENSILER NM Damer, 03. august 2010

♠ 42 Mappen: 29(61)
 ♥ QJ98762 Rundenr: 31
 ♦ 5 A (N)
 ♣ J87

♠ 953
 ♥ K543
 ♦ A876
 ♣ QT

♠ QT876
 ♥ QJ43
 ♣ A652

♠ T952 Mappen: 31(63)
 ♥ 96 Rundenr: 32
 ♦ J42 NS (S)
 ♣ K876

♠ AK8
 ♥ JT87
 ♦ KQ86
 ♣ 54

♠ 7643
 ♥ KQ
 ♦ 73
 ♣ QJ932

♠ QJ
 ♥ A5432
 ♦ AT95
 ♣ AT

Bord	NS	ØV	NS	ØV	NS	ØV
12	20	42	3NT	V 8	100	19,0 -19,0
9	39	23	3NT	Ø 8	100	19,0 -19,0
6	36	26	5Ruter	Ø 10	100	19,0 -19,0
3	33	29	2NT	V 8	120	15,0 -15,0
4	34	28	3Ruter	V 10	130	13,0 -13,0
8	38	24	3NT	Ø 9	600	4,0 -4,0
13	43	19	3NT	Ø 9	600	4,0 -4,0
18	14	5	3NT	Ø 9	600	4,0 -4,0
11	21	41	3NT	Ø 9	600	4,0 -4,0
7	25	37	3NT	V 9	600	4,0 -4,0
20	7	12	3NT	V 9	600	4,0 -4,0
17	15	4	3NT	V 9	600	4,0 -4,0
5	27	35	3NT	Ø 9	600	4,0 -4,0
2	30	32	3NT	Ø 10	630	-9,0 9,0
21	8	11	3NT	Ø 10	630	-9,0 9,0
10	22	40	3NT	Ø 10	630	-9,0 9,0
15	17	2	3NT	Ø 10	630	-9,0 9,0
19	6	13	3NT	Ø 10	630	-9,0 9,0
16	16	3	3NT	Ø 11	660	-17,0 17,0
22	10	9	3NT	Ø 11	660	-17,0 17,0
1	44	31	3NT	Ø 11	660	-17,0 17,0
14	18	1	3Hjertes	D N 5	1100	-21,0 21,0

Bord	NS	ØV	NS	ØV	NS	ØV
15	18	3	3Klover	Ø 7	100	19,0 -19,0
5	28	36	3NT	V 7	100	19,0 -19,0
10	23	41	3Spar	Ø 7	100	19,0 -19,0
4	35	29	1NT	S 7	90	15,0 -15,0
20	8	13	1Hjertes	S 7	80	8,0 -8,0
16	17	4	1Hjertes	S 7	80	8,0 -8,0
18	15	6	1Hjertes	S 7	80	8,0 -8,0
6	37	27	1Hjertes	S 7	80	8,0 -8,0
21	9	12	1Hjertes	S 7	80	8,0 -8,0
11	22	42	1Hjertes	S 7	80	8,0 -8,0
8	39	25	1NT	V 6	50	1,0 -1,0
14	19	2	1Hjertes	S 6	100	-7,0 7,0
7	26	38	1Hjertes	S 6	100	-7,0 7,0
12	21	43	1Hjertes	S 6	100	-7,0 7,0
9	40	24	1Hjertes	N 6	100	-7,0 7,0
13	1	20	1Hjertes	N 6	100	-7,0 7,0
3	34	30	2Hjertes	S 7	100	-7,0 7,0
1	44	32	2Hjertes	S 7	100	-7,0 7,0
19	7	14	1Spar	Ø 8	110	-15,0 15,0
2	31	33	1Hjertes	S 5	200	-19,0 19,0
22	11	10	1Hjertes	S 5	200	-19,0 19,0
17	16	5	1Hjertes	S 5	200	-19,0 19,0

♠ QJ8 Mappen: 30(62)
 ♥ A92 Rundenr: 31
 ♦ A5 I (Ø)
 ♣ QT872

♠ 9762
 ♥ Q4
 ♦ QT9
 ♣ AK64

♠ K4
 ♥ KJT653
 ♦ K872
 ♣ 5

♠ T8 Mappen: 32(64)
 ♥ 43 Rundenr: 32
 ♦ Q82 ØV (V)
 ♣ AKQJ76

♠ Q542
 ♥ KQ
 ♦ AKJT6
 ♣ 85

♠ K63
 ♥ AT7652
 ♦ 9
 ♣ T43

♠ AJ97
 ♥ J98
 ♦ 7543
 ♣ 92

Bord	NS	ØV	NS	ØV	NS	ØV
15	17	2	4Hjertes	S 11	450	12,0 -12,0
12	20	42	4Hjertes	N 11	450	12,0 -12,0
9	39	23	4Hjertes	S 11	450	12,0 -12,0
10	22	40	4Hjertes	S 11	450	12,0 -12,0
8	38	24	4Hjertes	S 11	450	12,0 -12,0
19	6	13	4Hjertes	S 11	450	12,0 -12,0
20	7	12	4Hjertes	S 11	450	12,0 -12,0
18	14	5	4Hjertes	S 11	450	12,0 -12,0
13	43	19	4Hjertes	S 11	450	12,0 -12,0
11	21	41	4Hjertes	S 11	450	12,0 -12,0
3	33	29	3NT	N 10	430	1,0 -1,0
2	30	32	4Hjertes	S 10	420	-1,0 1,0
14	18	1	3Spar	Ø 4	250	-3,0 3,0
7	25	37	2Hjertes	S 11	200	-9,0 9,0
4	34	28	2Hjertes	N 11	200	-9,0 9,0
5	27	35	3Hjertes	S 11	200	-9,0 9,0
1	44	31	3Hjertes	S 11	200	-9,0 9,0
6	36	26	3Spar	Ø 5	200	-9,0 9,0
16	16	3	2Hjertes	S 10	170	-18,0 18,0
22	10	9	2Hjertes	S 10	170	-18,0 18,0
21	8	11	2Hjertes	S 10	170	-18,0 18,0
17	15	4	3Hjertes	S 10	170	-18,0 18,0

Bord	NS	ØV	NS	ØV	NS	ØV
8	39	25	3NT	V 5	400	20,0 -20,0
1	44	32	4Spar	V 6	400	20,0 -20,0
16	17	4	2Spar	V 7	100	10,0 -10,0
3	34	30	3Spar	V 8	100	10,0 -10,0
15	18	3	4Hjertes	V 9	100	10,0 -10,0
21	9	12	4Hjertes	V 9	100	10,0 -10,0
12	21	43	4Hjertes	Ø 9	100	10,0 -10,0
13	1	20	4Hjertes	Ø 9	100	10,0 -10,0
11	22	42	4Hjertes	V 9	100	10,0 -10,0
5	28	36	4Hjertes	Ø 9	100	10,0 -10,0
7	26	38	2Spar	V 8	110	0,0 0,0
17	16	5	2Spar	V 8	110	0,0 0,0
10	23	41	2Hjertes	V 9	140	-7,0 7,0
6	37	27	2Hjertes	V 9	140	-7,0 7,0
14	19	2	3Hjertes	Ø 9	140	-7,0 7,0
2	31	33	3Hjertes	V 9	140	-7,0 7,0
20	8	13	3Hjertes	V 9	140	-7,0 7,0
18	15	6	3Hjertes	Ø 10	170	-13,0 13,0
22	11	10	4Hjertes	V 10	620	-17,0 17,0
9	40	24	4Hjertes	Ø 10	620	-17,0 17,0
19	7	14	4Hjertes	V 10	620	-17,0 17,0
4	35	29	6Klover	D N 7	1100	-21,0 21,0

SPILLSTENSILER NM Damer, 03. august 2010

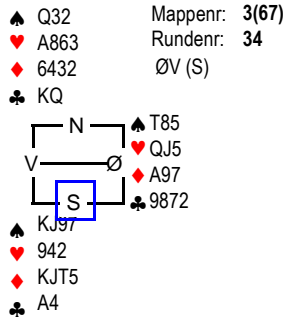
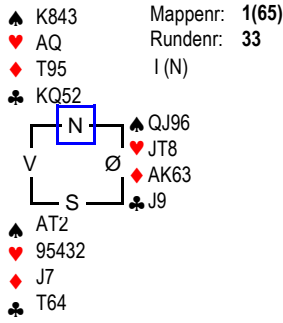

Bord	NS	ØV		NS	ØV	NS	ØV
15	19	4	1 Spar	N 8	110	20,0	-20,0
9	41	25	2 Hjerter	S 8	110	20,0	-20,0
11	23	43	1 NT	V 5	100	16,0	-16,0
18	16	7	1 NT	V 5	100	16,0	-16,0
16	18	5	1 NT	N 7	90	12,0	-12,0
12	22	1	1 NT	N 7	90	12,0	-12,0
10	24	42	1 Kløver	N 7	70	9,0	-9,0
2	32	34	2 Ruter	Ø 7	50	6,0	-6,0
13	2	21	2 Ruter	V 7	50	6,0	-6,0
8	40	26	2 Hjerter	N 7	50	3,0	-3,0
14	20	3	1 NT	V 7	90	-4,0	4,0
19	8	15	1 NT	V 7	90	-4,0	4,0
7	27	39	1 NT	V 7	90	-4,0	4,0
4	36	30	2 Ruter	V 8	90	-4,0	4,0
21	10	13	2 Ruter	V 8	90	-4,0	4,0
22	12	11	2 Ruter	Ø 8	90	-4,0	4,0
17	17	6	2 Ruter	V 9	110	-12,0	12,0
3	35	31	2 Ruter	V 9	110	-12,0	12,0
5	29	37	1 NT	V 8	120	-17,0	17,0
6	38	28	1 NT	V 8	120	-17,0	17,0
20	9	14	1 NT	V 8	120	-17,0	17,0
1	44	33	1 NT	V 9	150	-21,0	21,0

Bord	NS	ØV		NS	ØV	NS	ØV
22	13	12	3 Kløver	D V 7	500	21,0	-21,0
1	44	34	3 Ruter	S 9	110	19,0	-19,0
2	33	35	1 NT	N 7	90	14,0	-14,0
20	10	15	1 Ruter	S 8	90	14,0	-14,0
5	30	38	2 Ruter	S 8	90	14,0	-14,0
17	18	7	2 Ruter	N 8	90	14,0	-14,0
14	21	4	1 NT	N 6	50	5,0	-5,0
6	39	29	2 NT	N 7	50	5,0	-5,0
19	9	16	2 NT	N 7	50	5,0	-5,0
9	42	26	2 NT	N 7	50	5,0	-5,0
11	24	1	3 NT	N 8	50	5,0	-5,0
12	23	2	1 NT	S 5	100	-10,0	10,0
8	41	27	1 NT	N 5	100	-10,0	10,0
13	3	22	1 NT	N 5	100	-10,0	10,0
15	20	5	2 NT	N 6	100	-10,0	10,0
21	11	14	2 NT	N 6	100	-10,0	10,0
10	25	43	2 NT	N 6	100	-10,0	10,0
16	19	6	2 NT	N 6	100	-10,0	10,0
18	17	8	2 NT	N 6	100	-10,0	10,0
7	28	40	2 NT	N 6	100	-10,0	10,0
3	36	32	3 Hjerter	N 7	100	-10,0	10,0
4	37	31	2 NT	N 5	150	-21,0	21,0

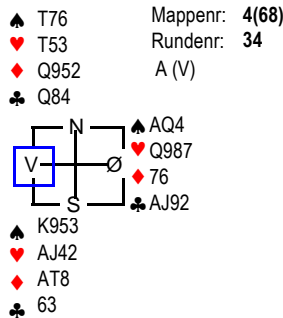
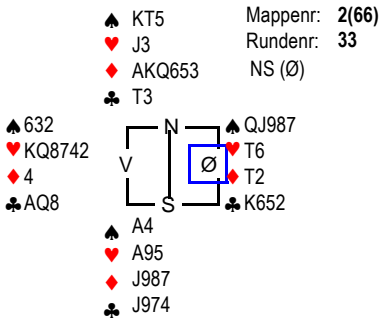

Bord	NS	ØV		NS	ØV	NS	ØV
15	19	4	3 NT	S 10	630	19,0	-19,0
9	41	25	3 NT	S 10	630	19,0	-19,0
14	20	3	3 NT	N 10	630	19,0	-19,0
18	16	7	2 Ruter	D N 9	380	15,0	-15,0
4	36	30	3 Ruter	N 11	150	13,0	-13,0
21	10	13	3 Ruter	N 10	130	4,0	-4,0
13	2	21	3 Ruter	N 10	130	4,0	-4,0
12	22	1	3 Ruter	N 10	130	4,0	-4,0
19	8	15	3 Ruter	N 10	130	4,0	-4,0
10	24	42	3 Ruter	N 10	130	4,0	-4,0
11	23	43	4 Ruter	N 10	130	4,0	-4,0
17	17	6	4 Ruter	N 10	130	4,0	-4,0
22	12	11	4 Ruter	N 10	130	4,0	-4,0
6	38	28	4 Spar	Ø 8	100	-5,0	5,0
7	27	39	3 Hjerter	V 8	50	-10,0	10,0
1	44	33	3 Hjerter	V 8	50	-10,0	10,0
16	18	5	3 Hjerter	V 8	50	-10,0	10,0
8	40	26	4 Spar	Ø 9	50	-10,0	10,0
2	32	34	5 Ruter	N 10	100	-15,0	15,0
5	29	37	2 Spar	Ø 9	140	-19,0	19,0
3	35	31	3 Hjerter	V 9	140	-19,0	19,0
20	9	14	3 Spar	Ø 9	140	-19,0	19,0

Bord	NS	ØV		NS	ØV	NS	ØV
9	42	26	2 NT	V 6	200	19,0	-19,0
1	44	34	3 NT	V 7	200	19,0	-19,0
6	39	29	3 NT	V 7	200	19,0	-19,0
18	17	8	2 NT	V 7	100	11,0	-11,0
20	10	15	2 NT	V 7	100	11,0	-11,0
12	23	2	3 NT	V 8	100	11,0	-11,0
4	37	31	3 NT	Ø 8	100	11,0	-11,0
5	30	38	3 NT	V 8	100	11,0	-11,0
3	36	32	1 NT	V 7	90	2,0	-2,0
15	20	5	1 NT	V 7	90	2,0	-2,0
7	28	40	1 NT	Ø 7	90	2,0	-2,0
8	41	27	1 NT	V 7	90	2,0	-2,0
13	3	22	2 Kløver	Ø 9	110	-4,0	4,0
22	13	12	2 Kløver	Ø 9	110	-4,0	4,0
11	24	1	1 NT	V 8	120	-10,0	10,0
16	19	6	1 NT	Ø 8	120	-10,0	10,0
17	18	7	2 NT	V 8	120	-10,0	10,0
21	11	14	2 NT	Ø 8	120	-10,0	10,0
2	33	35	2 NT	V 9	150	-15,0	15,0
19	9	16	2 Ruter	D N 6	500	-17,0	17,0
14	21	4	3 NT	Ø 9	600	-19,0	19,0
10	25	43	2 Ruter	D N 5	800	-21,0	21,0

SPILLSTENSILER NM Damer, 03. august 2010

♠ A82 Mappen: 5(69)
♥ AJ832 Rundenr: 35
♦ 973 NS (N)

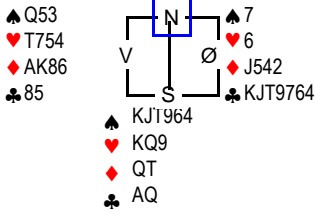

Bord	NS	ØV	NS	ØV	NS	ØV
20	11	16	5 Spar	D S 11	850	21,0 -21,0
13	4	23	4 Hjerter	S 13	710	16,0 -16,0
4	38	32	4 Hjerter	N 13	710	16,0 -16,0
12	24	3	4 Spar	S 13	710	16,0 -16,0
2	34	36	4 Spar	S 13	710	16,0 -16,0
1	44	35	4 Spar	S 12	680	10,0 -10,0
11	25	2	4 Spar	S 12	680	10,0 -10,0
7	29	41	4 Spar	S 11	650	3,0 -3,0
6	40	30	4 Spar	N 11	650	3,0 -3,0
3	37	33	4 Spar	S 11	650	3,0 -3,0
18	18	9	4 Spar	S 11	650	3,0 -3,0
9	43	27	4 Spar	S 11	650	3,0 -3,0
14	22	5	4 Spar	S 10	620	-10,0 10,0
17	19	8	4 Spar	S 10	620	-10,0 10,0
10	26	1	4 Spar	S 10	620	-10,0 10,0
21	12	15	4 Spar	S 10	620	-10,0 10,0
22	14	13	4 Spar	S 10	620	-10,0 10,0
8	42	28	4 Spar	S 10	620	-10,0 10,0
15	21	6	4 Spar	S 10	620	-10,0 10,0
19	10	17	4 Spar	S 10	620	-10,0 10,0
16	20	7	5 Klever	D Ø 9	300	-19,0 19,0
5	31	39	5 Spar	S 10	100	-21,0 21,0

♠ AJ6 Mappen: 7(71)
♥ QT65 Rundenr: 36
♦ K5 A (S)

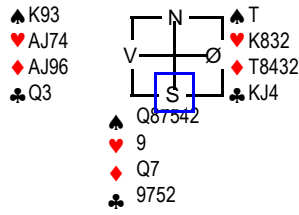

Bord	NS	ØV	NS	ØV	NS	ØV
18	19	10	3 Ruter	Ø 7	200	20,0 -20,0
8	43	29	4 Hjerter	V 8	200	20,0 -20,0
22	15	14	3 Spar	S 9	140	17,0 -17,0
7	30	42	2 Spar	S 8	110	15,0 -15,0
21	13	16	3 Hjerter	Ø 8	100	11,0 -11,0
6	41	31	3 Hjerter	V 8	100	11,0 -11,0
5	32	40	3 NT	V 8	100	11,0 -11,0
17	20	9	2 Hjerter	N 7	100	6,0 -6,0
20	12	17	3 Spar	S 8	100	6,0 -6,0
10	27	2	2 Hjerter	V 8	110	3,0 -3,0
3	38	34	1 NT	V 8	120	-4,0 4,0
4	39	33	1 NT	V 8	120	-4,0 4,0
11	26	3	1 NT	V 8	120	-4,0 4,0
16	21	8	1 NT	V 8	120	-4,0 4,0
9	1	28	1 NT	V 8	120	-4,0 4,0
2	35	37	2 NT	V 8	120	-4,0 4,0
15	22	7	3 Ruter	V 10	130	-11,0 11,0
14	23	6	1 NT	V 9	150	-15,0 15,0
12	25	4	1 NT	V 9	150	-15,0 15,0
1	44	36	1 NT	V 9	150	-15,0 15,0
19	11	18	1 NT	V 10	180	-19,0 19,0
13	5	24	3 NT	D V 9	750	-21,0 21,0

♠ JT63 Mappen: 6(70)
♥ AJ32 Rundenr: 35
♦ K9 ØV (Ø)

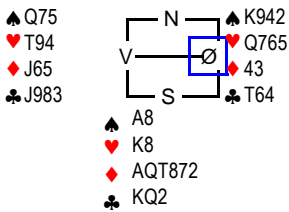

Bord	NS	ØV	NS	ØV	NS	ØV
10	26	1	6 NT	S 13	1020	19,0 -19,0
15	21	6	6 NT	S 13	1020	19,0 -19,0
3	37	33	6 NT	S 13	1020	19,0 -19,0
14	22	5	6 NT	S 12	990	9,0 -9,0
21	12	15	6 NT	S 12	990	9,0 -9,0
1	44	35	6 NT	S 12	990	9,0 -9,0
6	40	30	6 NT	N 12	990	9,0 -9,0
18	18	9	6 NT	S 12	990	9,0 -9,0
22	14	13	6 NT	S 12	990	9,0 -9,0
20	11	16	6 NT	S 12	990	9,0 -9,0
2	34	36	6 Ruter	S 12	920	-1,0 1,0
17	19	8	6 Ruter	S 12	920	-1,0 1,0
16	20	7	6 Ruter	S 12	920	-1,0 1,0
5	31	39	3 NT	N 13	520	-5,0 5,0
9	43	27	3 NT	S 12	490	-14,0 14,0
19	10	17	3 NT	N 12	490	-14,0 14,0
11	25	2	3 NT	S 12	490	-14,0 14,0
4	38	32	3 NT	S 12	490	-14,0 14,0
13	4	23	3 NT	S 12	490	-14,0 14,0
8	42	28	3 NT	S 12	490	-14,0 14,0
12	24	3	3 NT	S 12	490	-14,0 14,0
7	29	41	5 NT	S 12	490	-14,0 14,0

♠ 84 Mappen: 8(72)
♥ AKT9 Rundenr: 36
♦ AKQ9 I (V)

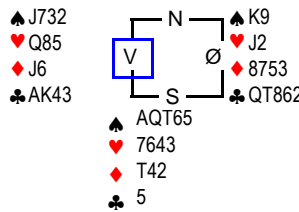

Bord	NS	ØV	NS	ØV	NS	ØV
8	43	29	2 Spar	D V 4	800	21,0 -21,0
13	5	24	4 Hjerter	N 11	450	19,0 -19,0
11	26	3	4 Hjerter	N 10	420	17,0 -17,0
15	22	7	2 Hjerter	N 12	230	14,0 -14,0
4	39	33	3 Hjerter	N 12	230	14,0 -14,0
10	27	2	2 Hjerter	N 10	170	10,0 -10,0
22	15	14	2 Spar	N 10	170	10,0 -10,0
14	23	6	2 Spar	N 9	140	0,0 0,0
12	25	4	2 Spar	N 9	140	0,0 0,0
18	19	10	2 Spar	S 9	140	0,0 0,0
16	21	8	2 Spar	N 9	140	0,0 0,0
20	12	17	2 Spar	N 9	140	0,0 0,0
1	44	36	2 Spar	S 9	140	0,0 0,0
17	20	9	2 Spar	N 9	140	0,0 0,0
2	35	37	2 Spar	N 9	140	0,0 0,0
9	1	28	3 Ruter	N 10	130	-9,0 9,0
7	30	42	2 Spar	N 8	110	-14,0 14,0
5	32	40	2 Spar	N 8	110	-14,0 14,0
6	41	31	2 Spar	N 8	110	-14,0 14,0
21	13	16	2 Spar	N 8	110	-14,0 14,0
3	38	34	2 Spar	N 7	50	-20,0 20,0
19	11	18	4 Hjerter	N 9	50	-20,0 20,0

SPILLSTENSILER NM Damer, 03. august 2010

♠ J94 Mappen: 9(73)
 ♥ QJ Rundenr: 37
 ♦ JT94 ØV (N)
 ♣ A875

♠ 862
 ♥ A62
 ♦ K7653
 ♣ KT

♠ A86 Mappen: 11(75)
 ♥ J43 Rundenr: 38
 ♦ KT64 I (S)
 ♣ T75

♠ KQT95
 ♥ A8
 ♦ QJ32
 ♣ 86

Bord	NS	ØV		NS	ØV	NS	ØV
20	13	18	4 Hjerter	S 11	450	20,0	-20,0
4	40	34	4 Hjerter	N 11	450	20,0	-20,0
19	12	19	3 NT	N 10	430	16,0	-16,0
5	33	41	3 NT	N 10	430	16,0	-16,0
10	28	3	4 Hjerter	S 10	420	4,0	-4,0
13	6	25	4 Hjerter	S 10	420	4,0	-4,0
7	31	43	4 Hjerter	S 10	420	4,0	-4,0
17	21	10	4 Hjerter	S 10	420	4,0	-4,0
8	1	30	4 Hjerter	S 10	420	4,0	-4,0
22	16	15	4 Hjerter	S 10	420	4,0	-4,0
2	36	38	4 Hjerter	S 10	420	4,0	-4,0
12	26	5	4 Hjerter	S 10	420	4,0	-4,0
6	42	32	4 Hjerter	S 10	420	4,0	-4,0
3	39	35	4 Hjerter	S 10	420	4,0	-4,0
16	22	9	3 NT	N 9	400	-8,0	8,0
1	44	37	3 NT	N 9	400	-8,0	8,0
15	23	8	2 Hjerter	S 10	170	-16,0	16,0
21	14	17	2 Hjerter	S 10	170	-16,0	16,0
14	24	7	2 Hjerter	S 10	170	-16,0	16,0
9	2	29	2 Hjerter	S 10	170	-16,0	16,0
18	20	11	2 Hjerter	S 10	170	-16,0	16,0
11	27	4	3 Hjerter	S 10	170	-16,0	16,0

Bord	NS	ØV		NS	ØV	NS	ØV
16	23	10	2 NT	Ø 11	210	21,0	-21,0
18	21	12	3 NT	Ø 9	400	7,0	-7,0
6	43	33	3 NT	Ø 9	400	7,0	-7,0
11	28	5	3 NT	Ø 9	400	7,0	-7,0
15	24	9	3 NT	Ø 9	400	7,0	-7,0
17	22	11	3 NT	Ø 9	400	7,0	-7,0
13	7	26	3 NT	Ø 9	400	7,0	-7,0
12	27	6	3 NT	Ø 9	400	7,0	-7,0
22	17	16	3 NT	Ø 9	400	7,0	-7,0
14	25	8	3 NT	Ø 9	400	7,0	-7,0
5	34	42	3 NT	Ø 9	400	7,0	-7,0
8	2	31	3 NT	Ø 9	400	7,0	-7,0
21	15	18	3 NT	Ø 9	400	7,0	-7,0
4	41	35	3 NT	Ø 9	400	7,0	-7,0
19	13	20	3 NT	Ø 10	430	-10,0	10,0
10	29	4	3 NT	Ø 10	430	-10,0	10,0
1	44	38	3 NT	Ø 10	430	-10,0	10,0
20	14	19	3 NT	Ø 10	430	-10,0	10,0
2	37	39	4 Hjerter	V 11	450	-17,0	17,0
9	3	30	4 Spar	Ø 11	450	-17,0	17,0
7	32	1	4 Spar	Ø 11	450	-17,0	17,0
3	40	36	4 Hjerter	Ø 12	480	-21,0	21,0

♠ A84 Mappen: 10(74)
 ♥ Q32 Rundenr: 37
 ♦ Q64 A (Ø)
 ♣ K953

♠ 53
 ♥ T854
 ♦ 853
 ♣ QT74

♠ 6 Mappen: 12(76)
 ♥ T7542 Rundenr: 38
 ♦ K962 NS (V)
 ♣ J85

♠ KT852
 ♥ AKJ
 ♦ Q43
 ♣ 42

Bord	NS	ØV		NS	ØV	NS	ØV
21	14	17	2 Kløver	D Ø 5	800	21,0	-21,0
2	36	38	1 NT	D V 6	200	19,0	-19,0
9	2	29	1 NT	N 10	180	17,0	-17,0
11	27	4	1 NT	N 8	120	10,0	-10,0
17	21	10	1 NT	N 8	120	10,0	-10,0
8	1	30	1 NT	N 8	120	10,0	-10,0
12	26	5	1 NT	N 8	120	10,0	-10,0
7	31	43	1 NT	N 8	120	10,0	-10,0
18	20	11	1 NT	S 8	120	10,0	-10,0
1	44	37	1 NT	V 6	100	2,0	-2,0
5	33	41	1 NT	V 6	100	2,0	-2,0
3	39	35	1 NT	N 7	90	-1,0	1,0
10	28	3	1 Spar	S 7	80	-3,0	3,0
13	6	25	1 NT	Ø 7	90	-5,0	5,0
16	22	9	1 NT	N 6	100	-11,0	11,0
22	16	15	1 NT	N 6	100	-11,0	11,0
6	42	32	1 NT	N 6	100	-11,0	11,0
14	24	7	2 NT	N 7	100	-11,0	11,0
15	23	8	2 NT	S 7	100	-11,0	11,0
4	40	34	2 Hjerter	Ø 8	110	-17,0	17,0
20	13	18	2 Kløver	S 6	200	-20,0	20,0
19	12	19	2 NT	N 6	200	-20,0	20,0

Bord	NS	ØV		NS	ØV	NS	ØV
1	44	38	4 Spar	V 8	100	18,0	-18,0
12	27	6	5 Spar	V 9	100	18,0	-18,0
21	15	18	5 Spar	V 9	100	18,0	-18,0
13	7	26	5 Spar	V 9	100	18,0	-18,0
22	17	16	3 NT	V 8	50	-4,0	4,0
11	28	5	4 Spar	V 9	50	-4,0	4,0
10	29	4	4 Spar	V 9	50	-4,0	4,0
18	21	12	4 Spar	V 9	50	-4,0	4,0
16	23	10	4 Spar	V 9	50	-4,0	4,0
14	25	8	4 Spar	V 9	50	-4,0	4,0
8	2	31	4 Spar	V 9	50	-4,0	4,0
15	24	9	4 Spar	V 9	50	-4,0	4,0
2	37	39	4 Spar	V 9	50	-4,0	4,0
6	43	33	4 Spar	V 9	50	-4,0	4,0
5	34	42	4 Spar	V 9	50	-4,0	4,0
9	3	30	4 Spar	V 9	50	-4,0	4,0
20	14	19	4 Spar	V 9	50	-4,0	4,0
17	22	11	4 Spar	V 9	50	-4,0	4,0
3	40	36	4 Spar	Ø 9	50	-4,0	4,0
4	41	35	4 Spar	V 9	50	-4,0	4,0
7	32	1	4 Spar	V 9	50	-4,0	4,0
19	13	20	4 Spar	V 9	50	-4,0	4,0

SPILLSTENSILER NM Damer, 03. august 2010

♠ AQJ986 Mappen: 13(77)
♥ KJ2 Rundenr: 39
♦ T6 A (N)
♣ KJ

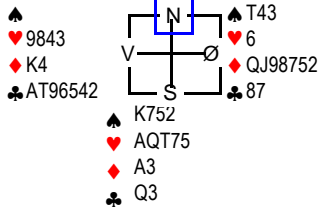

Bord	NS	ØV		NS	ØV	NS	ØV
13	8	27	6 Spar	N 13	1460	21,0	-21,0
19	14	21	6 Hjerter	S 12	1430	6,0	-6,0
10	30	5	6 Spar	N 12	1430	6,0	-6,0
18	22	13	6 Spar	N 12	1430	6,0	-6,0
1	44	39	6 Spar	N 12	1430	6,0	-6,0
8	3	32	6 Spar	N 12	1430	6,0	-6,0
14	26	9	6 Spar	N 12	1430	6,0	-6,0
7	33	2	6 Spar	N 12	1430	6,0	-6,0
3	41	37	6 Spar	N 12	1430	6,0	-6,0
9	4	31	6 Spar	N 12	1430	6,0	-6,0
22	18	17	6 Spar	N 12	1430	6,0	-6,0
11	29	6	6 Spar	N 12	1430	6,0	-6,0
20	15	20	6 Spar	N 12	1430	6,0	-6,0
4	42	36	6 Spar	N 12	1430	6,0	-6,0
6	1	34	6 Spar	N 12	1430	6,0	-6,0
5	35	43	4 Spar	N 13	710	-9,0	9,0
21	16	19	4 Spar	N 12	680	-16,0	16,0
15	25	10	4 Spar	N 12	680	-16,0	16,0
12	28	7	4 Spar	N 12	680	-16,0	16,0
16	24	11	5 Spar	N 12	680	-16,0	16,0
17	23	12	5 Spar	N 12	680	-16,0	16,0
2	38	40	5 Spar	N 12	680	-16,0	16,0

♠ 8 Mappen: 15(79)
♥ QT83 Rundenr: 40
♦ J8752 NS (S)
♣ AT2

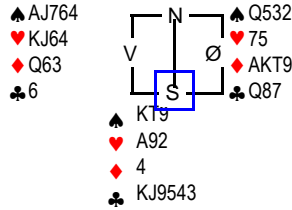

Bord	NS	ØV		NS	ØV	NS	ØV
20	16	21	3 Kløver	S 9	110	21,0	-21,0
15	26	11	4 Spar	V 9	50	18,0	-18,0
18	23	14	4 Spar	V 9	50	18,0	-18,0
2	39	41	4 Kløver	S 9	100	15,0	-15,0
14	27	10	2 Spar	V 9	140	12,0	-12,0
1	44	40	3 Spar	V 9	140	12,0	-12,0
8	4	33	3 Spar	V 10	170	6,0	-6,0
12	29	8	3 Spar	V 10	170	6,0	-6,0
6	2	35	3 Spar	V 10	170	6,0	-6,0
22	19	18	3 Spar	V 10	170	6,0	-6,0
10	31	6	2 Spar	V 11	200	0,0	0,0
9	5	32	5 Kløver	D S 10	200	0,0	0,0
4	43	37	4 Spar	V 10	420	-11,0	11,0
13	9	28	4 Spar	V 10	420	-11,0	11,0
5	36	1	4 Spar	V 10	420	-11,0	11,0
7	34	3	4 Spar	V 10	420	-11,0	11,0
16	25	12	4 Spar	V 10	420	-11,0	11,0
11	30	7	4 Spar	V 10	420	-11,0	11,0
3	42	38	4 Spar	V 10	420	-11,0	11,0
21	17	20	4 Spar	V 10	420	-11,0	11,0
17	24	13	4 Spar	Ø 10	420	-11,0	11,0
19	15	22	4 Spar	D V 10	590	-21,0	21,0

♠ J96542 Mappen: 14(78)
♥ 953 Rundenr: 39
♦ 9 I (Ø)
♣ J87

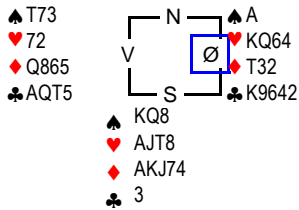

Bord	NS	ØV		NS	ØV	NS	ØV
13	8	27	4 Spar	N 10	420	17,0	-17,0
16	24	11	4 Spar	N 10	420	17,0	-17,0
19	14	21	4 Spar	N 10	420	17,0	-17,0
18	22	13	4 Spar	N 10	420	17,0	-17,0
1	44	39	4 Spar	N 10	420	17,0	-17,0
15	25	10	2 Spar	N 11	200	11,0	-11,0
5	35	43	2 Spar	N 10	170	5,0	-5,0
21	16	19	2 Spar	N 10	170	5,0	-5,0
9	4	31	3 Spar	N 10	170	5,0	-5,0
7	33	2	3 Spar	N 10	170	5,0	-5,0
8	3	32	3 Spar	N 10	170	5,0	-5,0
14	26	9	2 Hjerter	S 7	50	-6,0	6,0
3	41	37	2 Hjerter	S 7	50	-6,0	6,0
11	29	6	3 Spar	N 8	50	-6,0	6,0
6	1	34	4 Spar	N 9	50	-6,0	6,0
20	15	20	4 Spar	N 9	50	-6,0	6,0
12	28	7	4 Spar	N 9	50	-6,0	6,0
10	30	5	3 Kløver	Ø 9	110	-14,0	14,0
17	23	12	3 Kløver	Ø 9	110	-14,0	14,0
4	42	36	3 Kløver	Ø 10	130	-17,0	17,0
2	38	40	2 Kløver	D Ø 9	280	-19,0	19,0
22	18	17	4 Kløver	D Ø 10	510	-21,0	21,0

♠ J8 Mappen: 16(80)
♥ KQT52 Rundenr: 40
♦ A4 ØV (V)
♣ AQ96

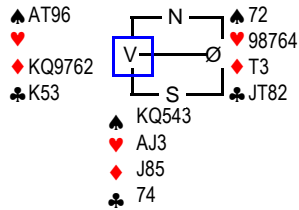

Bord	NS	ØV		NS	ØV	NS	ØV
12	29	8	4 Hjerter	D N 10	590	20,0	-20,0
8	4	33	4 Hjerter	D N 10	590	20,0	-20,0
3	42	38	3 NT	N 10	430	17,0	-17,0
9	5	32	4 Hjerter	N 10	420	11,0	-11,0
11	30	7	4 Hjerter	N 10	420	11,0	-11,0
22	19	18	4 Hjerter	N 10	420	11,0	-11,0
18	23	14	4 Hjerter	N 10	420	11,0	-11,0
20	16	21	4 Hjerter	N 10	420	11,0	-11,0
21	17	20	3 NT	N 9	400	5,0	-5,0
15	26	11	2 NT	S 10	180	3,0	-3,0
7	34	3	2 Spar	S 8	110	1,0	-1,0
14	27	10	3 NT	N 8	50	-6,0	6,0
6	2	35	4 Hjerter	N 9	50	-6,0	6,0
4	43	37	4 Hjerter	N 9	50	-6,0	6,0
5	36	1	4 Hjerter	N 9	50	-6,0	6,0
19	15	22	4 Hjerter	N 9	50	-6,0	6,0
13	9	28	4 Spar	N 9	50	-6,0	6,0
10	31	6	4 Hjerter	N 8	100	-16,0	16,0
16	25	12	4 Hjerter	N 8	100	-16,0	16,0
17	24	13	4 Hjerter	N 8	100	-16,0	16,0
2	39	41	4 Spar	S 8	100	-16,0	16,0
1	44	40	4 Spar	S 7	150	-21,0	21,0

SPILLSTENSILER NM Damer, 03. august 2010

♠ AQ864 Mappen: 17(81)
 ♥ QJ Rundenr: 41
 ♦ JT976 I (N)
 ♣ 3

♠ 7532
 ♥ 863
 ♦ AK
 ♣ AT72

♠ T9
 ♥ A752
 ♦ Q853
 ♣ K96

♠ Q543 Mappen: 19(83)
 ♥ 2 Rundenr: 42
 ♦ QJT8 ØV (S)
 ♣ A985

♠ T
 ♥ QJT65
 ♦ 765
 ♣ J762

♠ K962
 ♥ AK7
 ♦ AK9432
 ♣

Bord	NS	ØV		NS	ØV	NS	ØV
12	30	9	3Ruter	D N 9	470	21,0	-21,0
22	20	19	3Ruter	S 10	130	19,0	-19,0
2	40	42	2Ruter	N 9	110	11,0	-11,0
3	43	39	2Ruter	N 9	110	11,0	-11,0
20	17	22	2Ruter	N 9	110	11,0	-11,0
7	35	4	3Ruter	N 9	110	11,0	-11,0
16	26	13	3Ruter	N 9	110	11,0	-11,0
18	24	15	3Ruter	N 9	110	11,0	-11,0
8	5	34	3Ruter	N 9	110	11,0	-11,0
17	25	14	Pass			-2,0	2,0
14	28	11	Pass			-2,0	2,0
1	44	41	Pass			-2,0	2,0
19	16	23	Pass			-2,0	2,0
6	3	36	Pass			-2,0	2,0
10	32	7	Pass			-2,0	2,0
13	10	29	3Ruter	N 8	50	-10,0	10,0
15	27	12	3Ruter	N 8	50	-10,0	10,0
21	18	21	2Kløver	Ø 9	110	-13,0	13,0
11	31	8	2Spar	N 5	150	-16,0	16,0
9	6	33	2Spar	N 5	150	-16,0	16,0
4	1	38	2NT	S 3	250	-19,0	19,0
5	37	2	5Kløver	D Ø 11	550	-21,0	21,0

Bord	NS	ØV		NS	ØV	NS	ØV
20	18	23	5Hjarter	D V 7	1100	21,0	-21,0
9	7	34	6Ruter	S 12	920	19,0	-19,0
16	27	14	3Spar	D S 10	630	17,0	-17,0
11	32	9	4Spar	N 11	450	15,0	-15,0
6	4	37	4Spar	N 10	420	12,0	-12,0
21	19	22	4Spar	N 10	420	12,0	-12,0
3	1	40	4Spar	S 9	50	-3,0	3,0
13	11	30	4Spar	N 9	50	-3,0	3,0
17	26	15	4Spar	N 9	50	-3,0	3,0
8	6	35	4Spar	N 9	50	-3,0	3,0
7	36	5	4Spar	N 9	50	-3,0	3,0
18	25	16	4Spar	N 9	50	-3,0	3,0
14	29	12	6Ruter	S 11	50	-3,0	3,0
10	33	8	6Ruter	S 11	50	-3,0	3,0
22	21	20	6Ruter	S 11	50	-3,0	3,0
15	28	13	6Spar	N 11	50	-3,0	3,0
12	31	10	6Spar	N 11	50	-3,0	3,0
19	17	24	6Spar	N 11	50	-3,0	3,0
2	41	43	6Spar	N 11	50	-3,0	3,0
5	38	3	4Spar	N 8	100	-19,0	19,0
4	2	39	6Spar	N 10	100	-19,0	19,0
1	44	42	6Spar	N 10	100	-19,0	19,0

♠ QJT762 Mappen: 18(82)
 ♥ Q985 Rundenr: 41
 ♦ 97 NS (Ø)
 ♣ 2

♠ K983
 ♥ AK4
 ♦ AJT53
 ♣ T

♠ 54
 ♥ JT7
 ♦ 4
 ♣ AQJ9643

♠ AK83 Mappen: 20(84)
 ♥ 2 Rundenr: 42
 ♦ K63 A (V)
 ♣ K9852

♠ T6
 ♥ AK86
 ♦ 98542
 ♣ QJ

♠ J754
 ♥ J4
 ♦ AQ7
 ♣ T743

Bord	NS	ØV		NS	ØV	NS	ØV
18	24	15	2Kløver	D S 7	200	16,0	-16,0
7	35	4	2Kløver	D S 7	200	16,0	-16,0
22	20	19	3Kløver	D S 8	200	16,0	-16,0
8	5	34	3Kløver	D S 8	200	16,0	-16,0
2	40	42	3Kløver	D S 8	200	16,0	-16,0
14	28	11	3Kløver	D S 8	200	16,0	-16,0
5	37	2	3NT	Ø 9	400	8,0	-8,0
12	30	9	3NT	V 9	400	8,0	-8,0
13	10	29	5Ruter	Ø 12	420	5,0	-5,0
17	25	14	3Kløver	D S 7	500	-1,0	1,0
6	3	36	3Kløver	D S 7	500	-1,0	1,0
10	32	7	3Kløver	D S 7	500	-1,0	1,0
1	44	41	3Kløver	D S 7	500	-1,0	1,0
3	43	39	3Kløver	D S 7	500	-1,0	1,0
15	27	12	3Kløver	D S 6	800	-8,0	8,0
11	31	8	3Kløver	D S 6	800	-8,0	8,0
16	26	13	6Ruter	Ø 12	920	-16,0	16,0
19	16	23	6Ruter	Ø 12	920	-16,0	16,0
9	6	33	6Ruter	Ø 12	920	-16,0	16,0
4	1	38	6Ruter	Ø 12	920	-16,0	16,0
20	17	22	6Ruter	Ø 12	920	-16,0	16,0
21	18	21	6Ruter	Ø 12	920	-16,0	16,0

Bord	NS	ØV		NS	ØV	NS	ØV
15	28	13	2Spar	N 10	170	20,0	-20,0
22	21	20	3Spar	N 10	170	20,0	-20,0
8	6	35	2Spar	S 9	140	7,0	-7,0
4	2	39	3Spar	S 9	140	7,0	-7,0
14	29	12	3Spar	N 9	140	7,0	-7,0
9	7	34	3Spar	N 9	140	7,0	-7,0
19	17	24	3Spar	N 9	140	7,0	-7,0
21	19	22	3Spar	N 9	140	7,0	-7,0
10	33	8	3Spar	N 9	140	7,0	-7,0
20	18	23	3Spar	N 9	140	7,0	-7,0
6	4	37	3Spar	N 9	140	7,0	-7,0
1	44	42	3Spar	N 9	140	7,0	-7,0
5	38	3	3Spar	N 9	140	7,0	-7,0
3	1	40	2Spar	S 8	110	-5,0	5,0
17	26	15	4Hjarter	Ø 9	100	-9,0	9,0
13	11	30	4Hjarter	Ø 9	100	-9,0	9,0
16	27	14	4Hjarter	Ø 9	100	-9,0	9,0
11	32	9	3Spar	N 8	100	-14,0	14,0
2	41	43	4Spar	N 9	100	-14,0	14,0
12	31	10	3Hjarter	Ø 9	140	-18,0	18,0
18	25	16	3Hjarter	Ø 9	140	-18,0	18,0
7	36	5	4Spar	N 7	300	-21,0	21,0

SPILLSTENSILER NM Damer, 03. august 2010

♠ KJ43 Mappen: **21(85)**
 ♥ T764 Rundenr: **43**
 ♦ 64 NS (N)

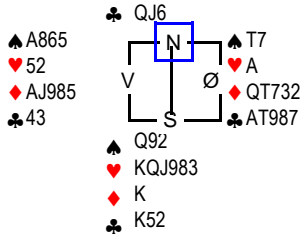

Bord	NS	ØV		NS	ØV	NS	ØV
2	42	1	3 Hjerter	D S 9	730	21,0	-21,0
6	5	38	2 Hjerter	S 10	170	19,0	-19,0
7	37	6	4 Ruter	N 11	150	17,0	-17,0
19	18	25	3 Hjerter	S 9	140	15,0	-15,0
21	20	23	4 Hjerter	S 9	100	13,0	-13,0
13	12	31	4 Ruter	Ø 11	150	3,0	-3,0
11	33	10	4 Ruter	V 11	150	3,0	-3,0
5	39	4	4 Ruter	Ø 11	150	3,0	-3,0
16	28	15	4 Ruter	Ø 11	150	3,0	-3,0
8	7	36	4 Ruter	Ø 11	150	3,0	-3,0
3	2	41	4 Ruter	Ø 11	150	3,0	-3,0
9	8	35	4 Ruter	Ø 11	150	3,0	-3,0
15	29	14	4 Ruter	V 11	150	3,0	-3,0
4	3	40	4 Ruter	Ø 11	150	3,0	-3,0
14	30	13	5 Ruter	V 11	400	-12,0	12,0
1	44	43	5 Ruter	Ø 11	400	-12,0	12,0
10	34	9	5 Ruter	Ø 11	400	-12,0	12,0
12	32	11	5 Ruter	Ø 11	400	-12,0	12,0
22	22	21	5 Ruter	Ø 11	400	-12,0	12,0
17	27	16	5 Ruter	V 11	400	-12,0	12,0
20	19	24	5 Ruter	D V 11	550	-19,0	19,0
18	26	17	5 Hjerter	D S 8	800	-21,0	21,0

♠ Q4 Mappen: **22(86)**
 ♥ 9854 Rundenr: **43**
 ♦ Q9432 ØV (Ø)

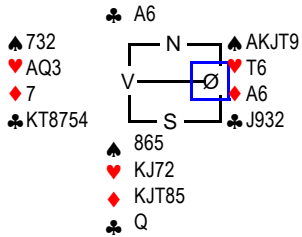

Bord	NS	ØV		NS	ØV	NS	ØV
1	44	43	3 Ruter	S 7	100	20,0	-20,0
13	12	31	4 Ruter	S 8	100	20,0	-20,0
8	7	36	4 Ruter	S 7	150	16,0	-16,0
21	20	23	4 Ruter	S 7	150	16,0	-16,0
4	3	40	3 Spar	Ø 10	170	13,0	-13,0
18	26	17	2 Spar	Ø 11	200	8,0	-8,0
22	22	21	3 Spar	Ø 11	200	8,0	-8,0
19	18	25	3 Spar	Ø 11	200	8,0	-8,0
11	33	10	5 Ruter	S 7	200	8,0	-8,0
6	5	38	3 Spar	Ø 12	230	3,0	-3,0
20	19	24	5 Kløver	V 12	620	1,0	-1,0
14	30	13	4 Spar	Ø 11	650	-4,0	4,0
15	29	14	4 Spar	Ø 11	650	-4,0	4,0
12	32	11	4 Spar	Ø 11	650	-4,0	4,0
3	2	41	4 Spar	Ø 11	650	-4,0	4,0
17	27	16	4 Spar	Ø 12	680	-12,0	12,0
5	39	4	4 Spar	Ø 12	680	-12,0	12,0
7	37	6	4 Spar	Ø 12	680	-12,0	12,0
10	34	9	5 Spar	Ø 12	680	-12,0	12,0
9	8	35	5 Ruter	D S 7	800	-18,0	18,0
16	28	15	5 Ruter	D S 7	800	-18,0	18,0
2	42	1	4 Spar	D Ø 11	990	-21,0	21,0